

# ANTONANGELI CONTEMPORARY DESIGN

## INDOOR & OUTDOOR COLLECTIONS



# ANTONANGELI CONTEMPORARY DESIGN

## INDOOR & OUTDOOR COLLECTIONS

### LA MATERIA E LA LUCE, DALL' INVENZIONE ALL' ARMONIA

Antonangeli Illuminazione nasce nel 1977, indirizzando la sua attenzione al design e alla creazione di corpi illuminanti di forte personalità, con la volontà di esprimere un concetto di luce che sia 'funzione' ed 'emozione' contemporaneamente.

Nel 2007 Antonangeli entra nel mondo dell'illuminazione esterna con una visione inedita: creare una luce che all'esterno producesse le emozioni e la vivibilità che crea la luce negli interni. Indagando il mercato e seguendo i suggerimenti di una nota paesaggista, Antonangeli dà avvio ad una serie di collezioni 'Outdoor', che ha come motto: 'bisogna rispettare il buio'.

La costante coerenza progettuale scaturisce dalla ricerca di soluzioni che non si limitano al semplice progetto formale, all'applicazione delle tecnologie, ma si cimenta con le materie e con i processi di lavorazione.

Questo fa di Antonangeli un unicum senza paragoni. Ogni collezione nasce da uno studio approfondito: su materiali nuovi o tradizionali trattati in modo esclusivo, su soluzioni produttive antiche o mai sperimentate. Il risultato sono forme di luce sorprendenti.

### MATTER AND LIGHT, FROM INVENTION TO HARMONY

Antonangeli Illuminazione was founded in 1977 and immediately directs his attention to the design and creation of lighting with a strong personality: focusing its interest on a concept of light that is 'function' and 'emotion' at the same time.

In 2007 enters the Outdoor lighting world – the outdoor with an unusual view hitherto: creating a light outside that would produce the same emotions and livability that normally creates the light in the interior. Carefully analyzing the market and the proposals and thanks to the suggestions of a landscape architect, Antonangeli gives rise to a serie of 'Outdoor' collections that has as its motto: 'we must respect the dark'.

Antonangeli offers solutions which go beyond the simple formal project and technical applications by experimenting with unusual materials which requires special working procedures. The Antonangeli's collections are made of a deep and patient study on traditional materials worked in a new way, new materials as well as productive solutions never before tested in the field of lighting. The result are exciting forms of lighting.

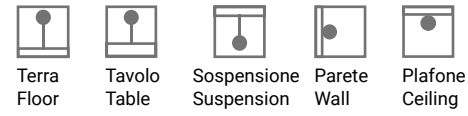

**INDOOR COLLECTION**

ARMONICA		80	
AURORA		90	
CINEMA'		98	
COUPE'		72	
CU-BOX		182	
DOLCEVITA		120	
FLAMBEAU		178	
FORMOSA		166	
GARDEN		134	
HULA-HOOP		26	
KAJ		114	

LE GINE		146	
LETTURA		54	
LIBERA		48	
LUNAE		20	
MAKE UP		186	
MAMAMIA		30	
MIAMI		158	
NOVECENTO		162	
OPERA		86	
PENOMBRA		66	
PENELOPE		60	
RA		6	

RICAMI		152	
ROBIN HOOD		130	
SKYFALL		40	
SOUL		174	
TORCETTA'		124	
VIOLINO		142	
VIVA EDISON		108	
VOLO		94	

**OUTDOOR COLLECTION**

BANANO		192	
CONCRETA		244	
CU-BOX		266	

FLAMBEAU		230	
GIUNCO		250	
I-SNAP		234	
LIBERA		256	
MIAMI		208	
NOTTAMBULA		276	
POLLICINO		240	
PULCINELLA		272	
REGOLO		218	
RICAMI		224	
SOFFIO		200	
SOUL		260	

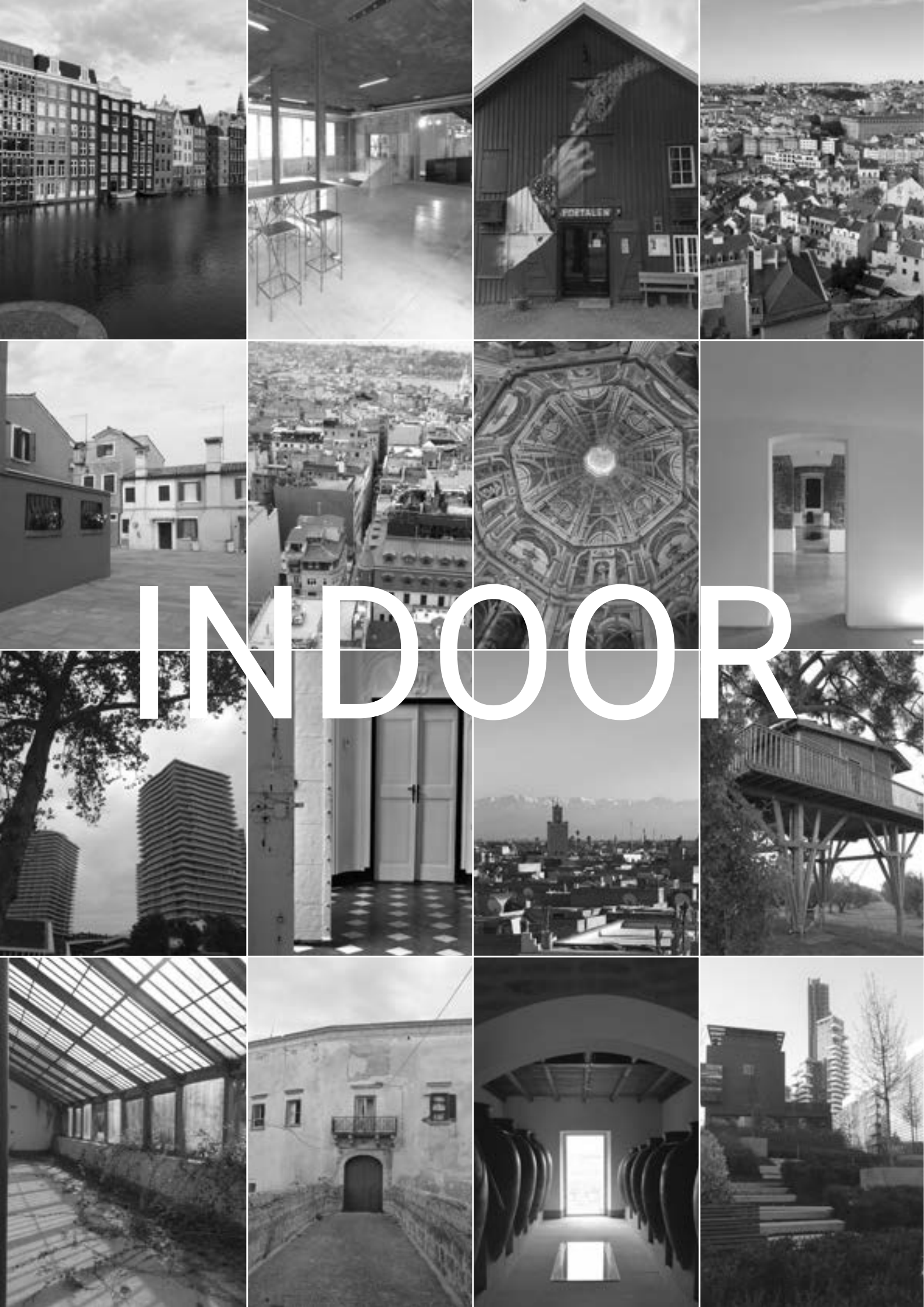

# INDOOR

*"E' un percorso iniziato quasi 50 anni fa, basato sulla ricerca, quello che ha permesso ad Antonangeli di costruire una forte e riconosciuta identità. Una ricerca duplice, tecnica e materica insieme, ha accompagnato lo sviluppo e l'indagine formale, generando la coerenza del percorso in sintonia alle modalità dell'abitare. Grazie al costante apporto creativo di progettisti, la storia della collezione Contemporary Design, è densa di realizzazioni innovative e di prodotti unici."*

*"It is a path started almost 50 years ago and based on research that has allowed Antonangeli to build a strong and recognised identity. Dual research, technical and material at the same time, has accompanied the development and formal investigation, generating the coherence of the path in tune with the way of living. Thanks to the constant creative contribution of designers, the history of the Contemporary Design collection is full of innovative realisations and unique products."*

Gianfranco Marabese 2024



# RA SYSTEM

design Gianfranco Marabese 2024



Ra System è una collezione innovativa: nell'utilizzo personalizzato della luce e nell'essenzialità del disegno. Sottili segmenti di luce disposti a raggiera e incastonati in cerchi perfetti, danno forma alla lampada. La facilità di rotazione dei segmenti, indipendenti tra loro, permette di modulare e direzionare l'illuminazione, secondo le esigenze specifiche: per creare atmosfere e scenografie esclusive.

Ra System is an innovative collection: in the personalized use of light and essentiality of design. Thin segments of light arranged in rays and set in perfect circles give shape to the lamp. The easy rotation of the independent light segments allows the lighting to be modulated and directed according to the specific needs of the user: to create exclusive atmospheres and settings.



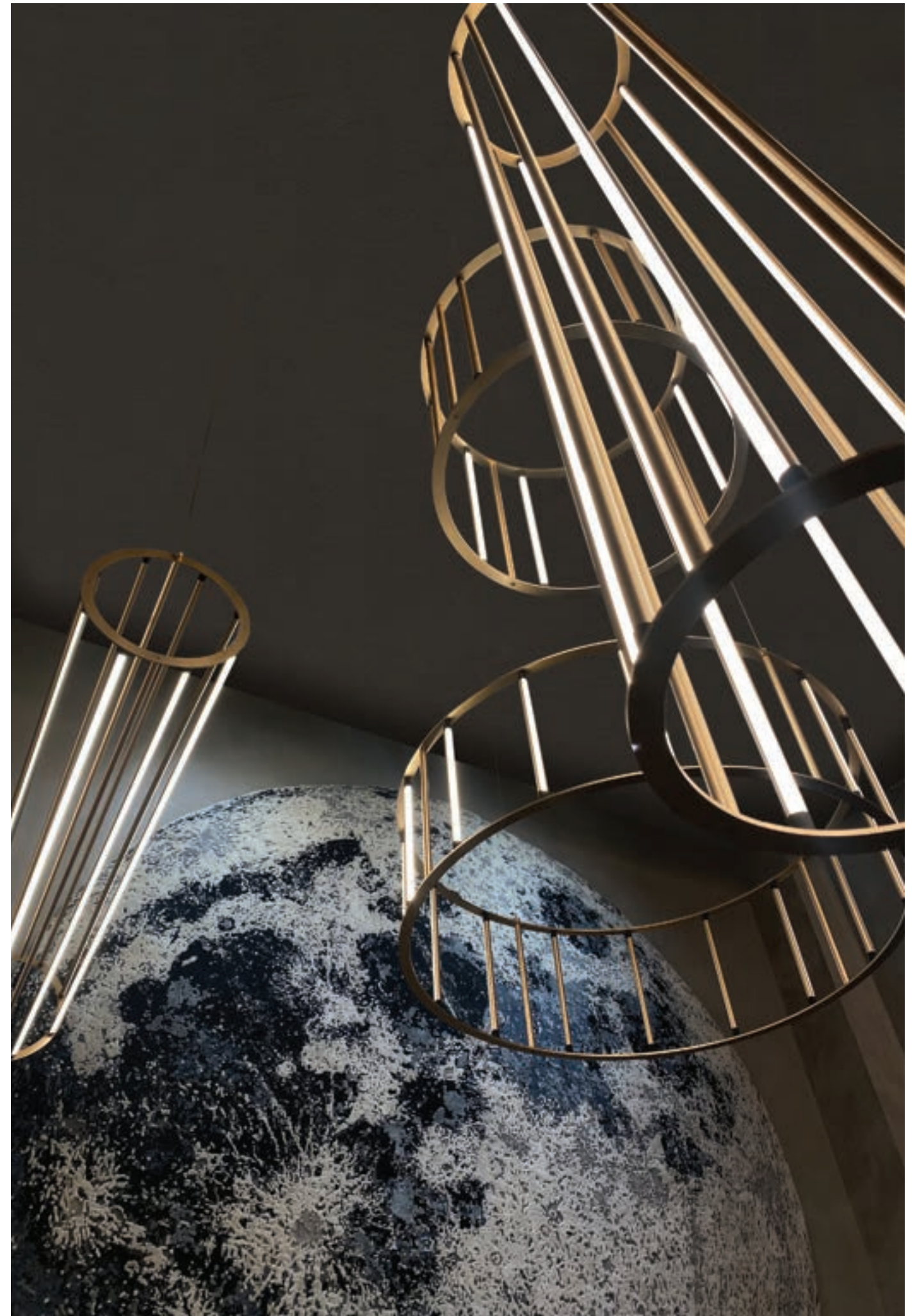



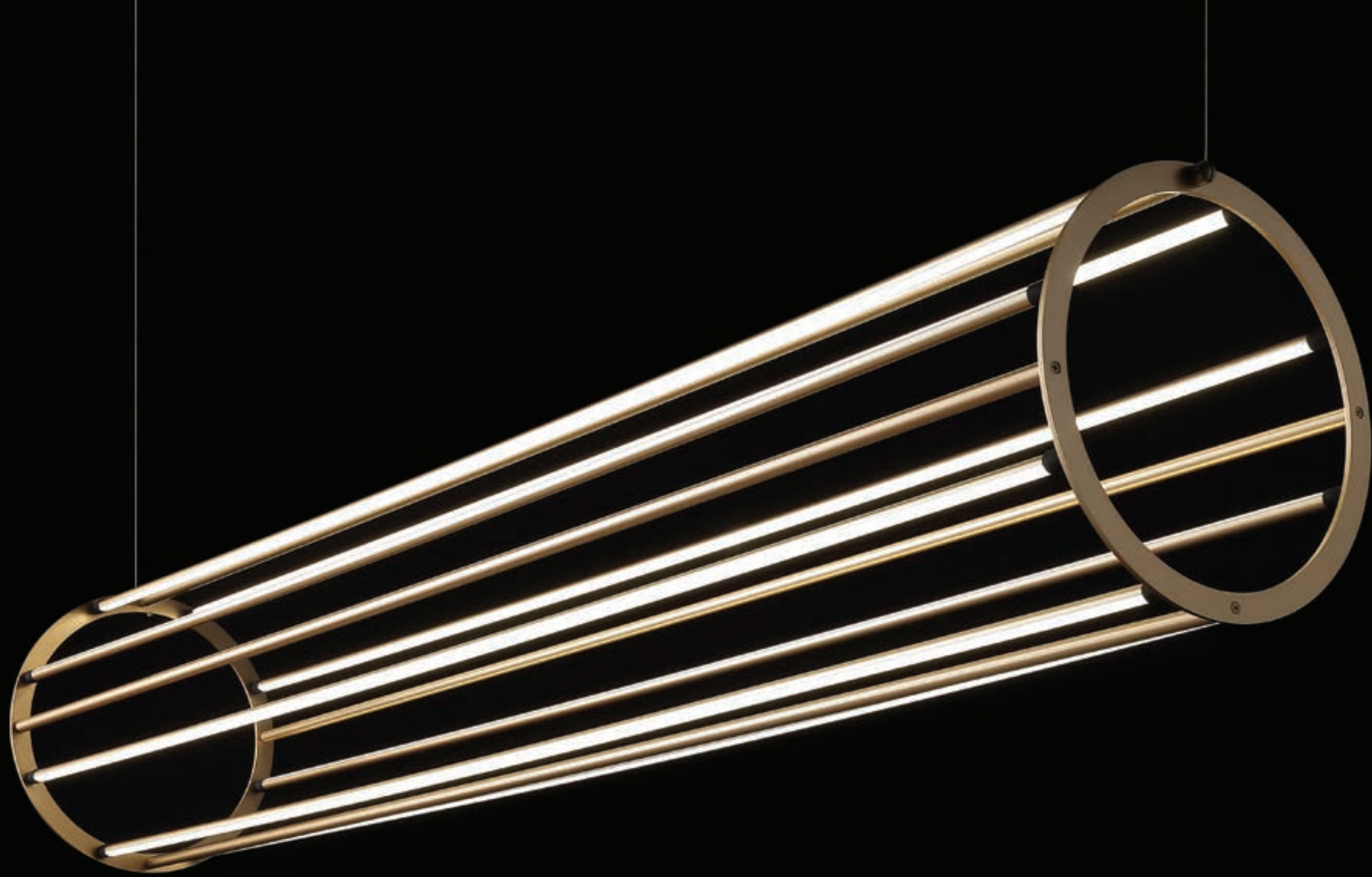

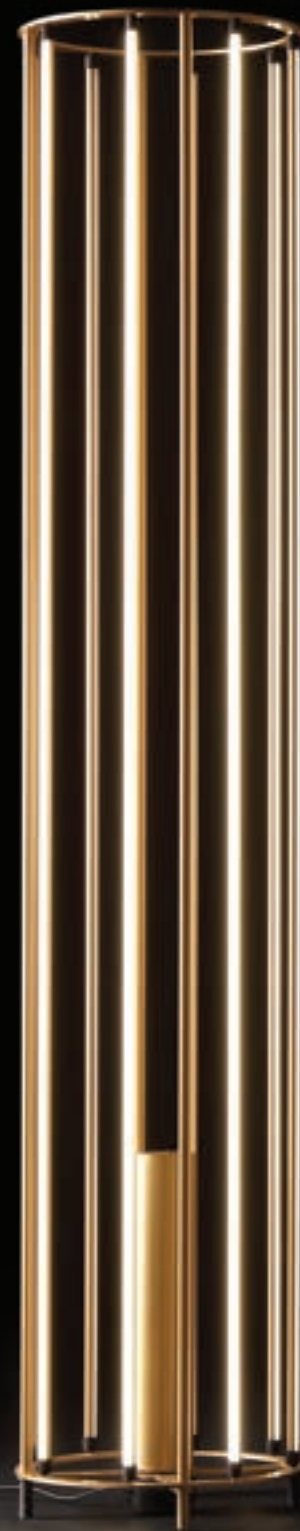





RA ROUND

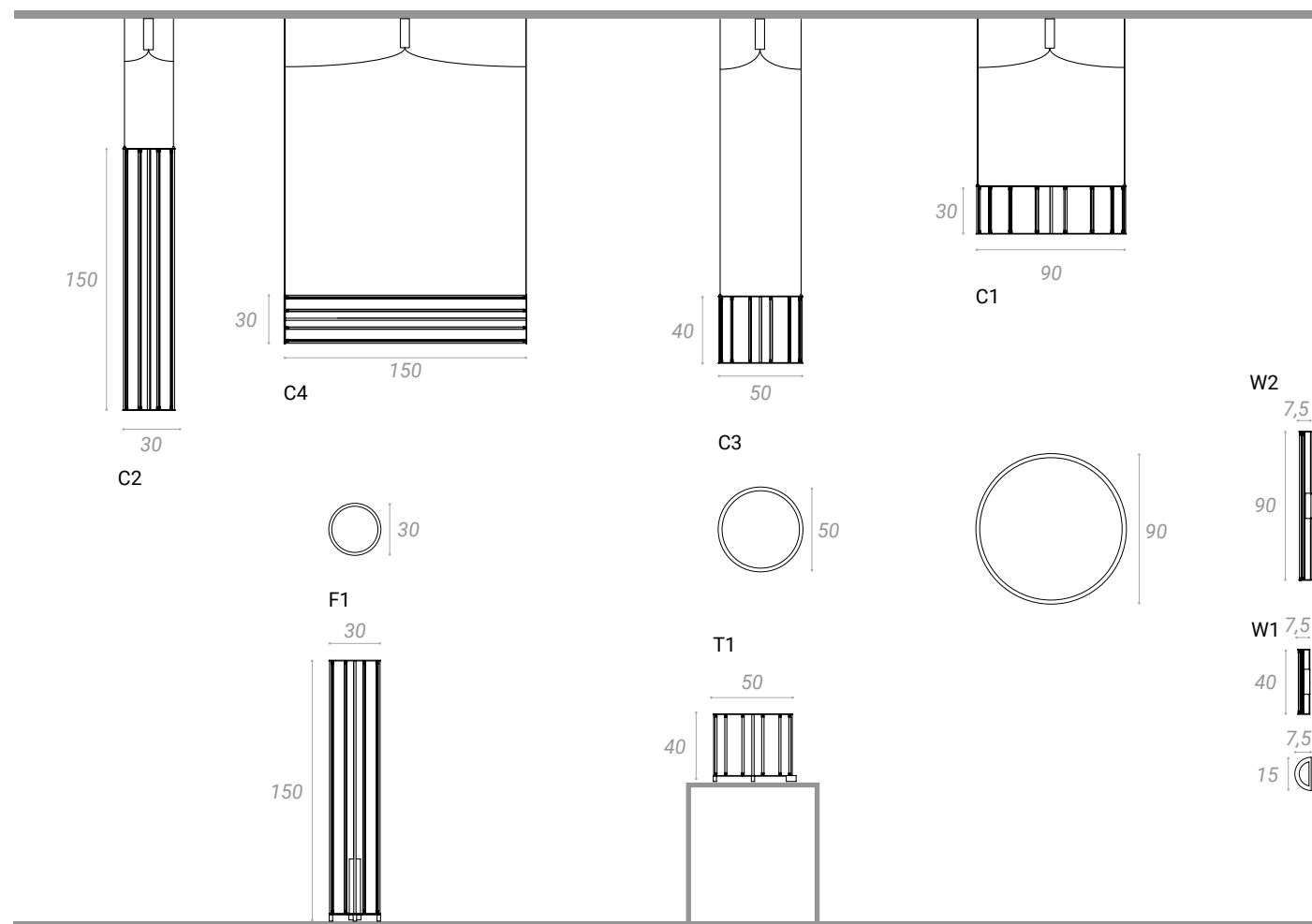

- C1 Led 2700°K 26W 24V
- C2 Led 2700°K 70W 24V
- C3 Led 2700°K 30W 24V
- C4 Led 2700°K 70W 24V
- F1 Led 2700°K 70W 24V
- T1 Led 2700°K 30W 24V
- W1 Led 2700°K 8W 24V
- W2 Led 2700°K 17W 24V

F1/T1 Dimmer included  

 C1/C2/C3/C4/W1/W2

RA OPEN

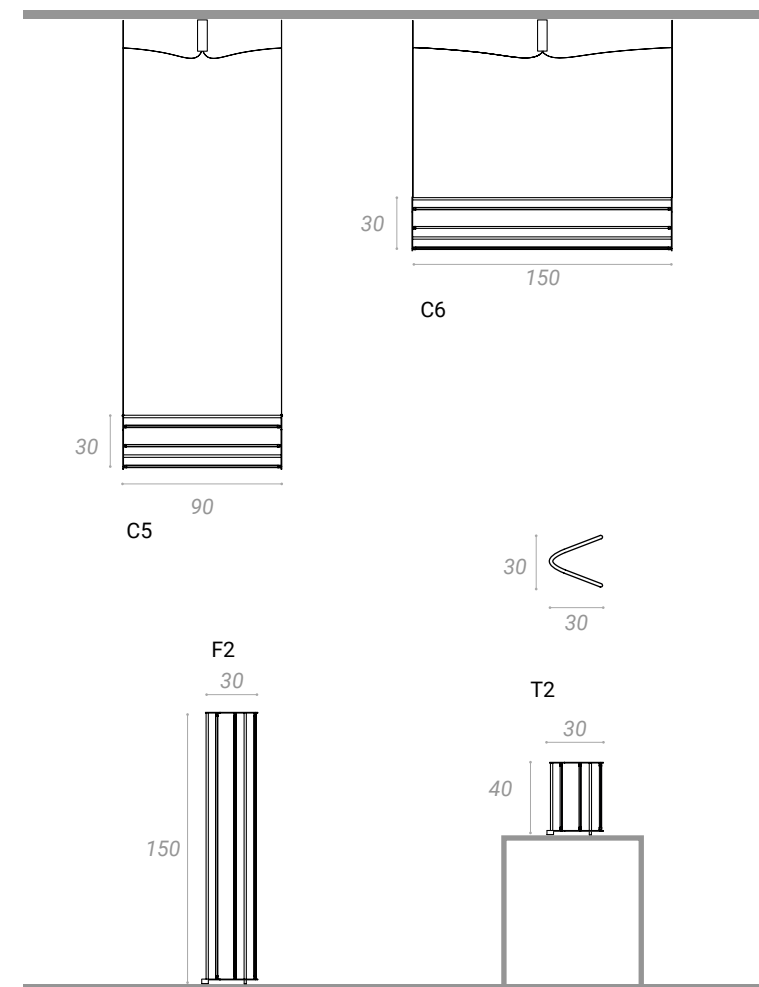

- C5 Led 2700°K 34W 24V
- C6 Led 2700°K 54W 24V
- F2 Led 2700°K 54W 24V
- T2 Led 2700°K 15W 24V
- C7 Led 2700°K 20W 24V
- F3 Led 2700°K 70W 24V

F2/F3/T2 Dimmer included  

 C5/C6/C7

RA FLAT

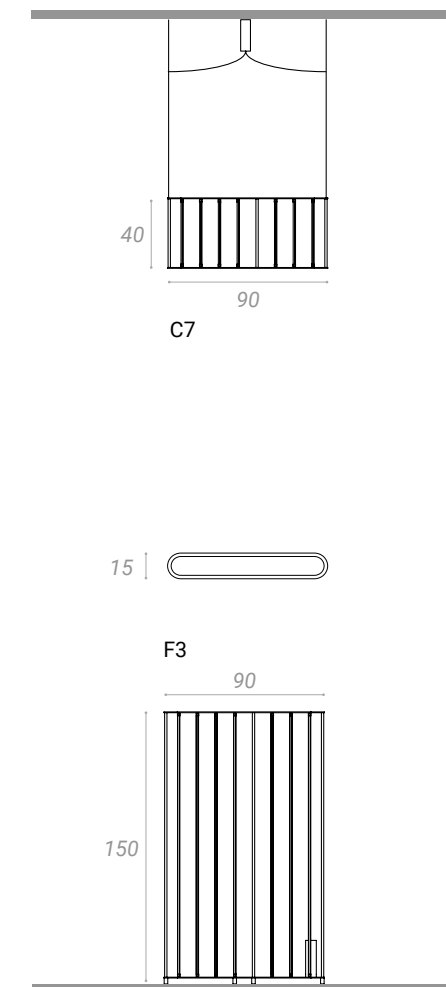

MATERIALI/MATERIALS  
metallo/metal

FINITURE/  
FINISHES

CROMO/  
CHROME

GRIGIO ANTRACITE/  
ANTHRACITE GRAY

ORO ANTICO/  
ANTIQUE GOLD

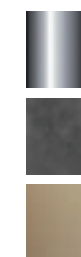



# LUNAE

design Gianfranco Marabese 2021

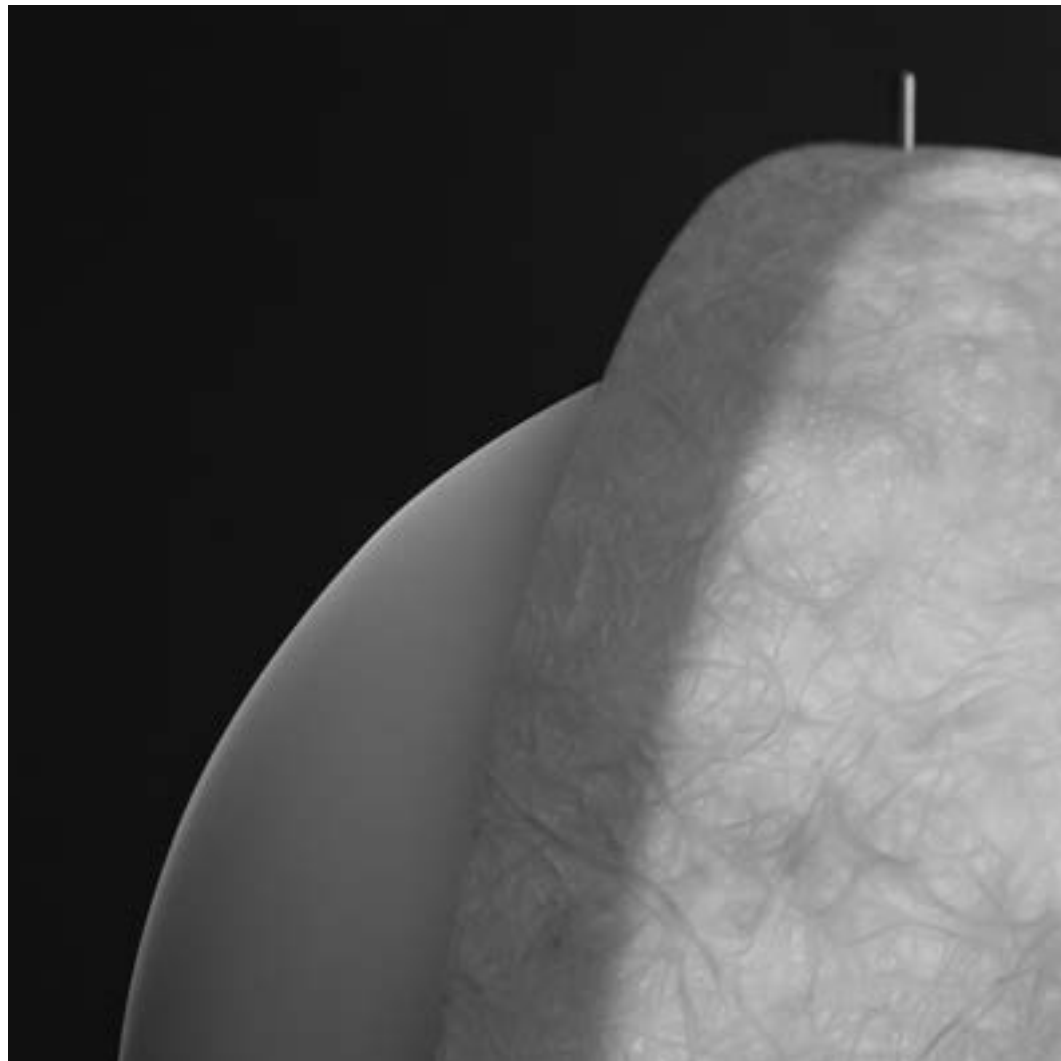

Un diffusore in fibra di vetro manifesta una superficie materica retro illuminata, che ricorda, l'immagine del suolo lunare. La rotazione su un'asse verticale di una 'controfigura' posta sul retro del diffusore consente di creare disegni che evocano le fasi lunari, creando differenti proiezioni di luce. L'interazione fra il prodotto e il suo fruitore permette di ottenere suggestive, magiche atmosfere.

A fibreglass diffuser shows a backlit material surface that by highlighting the material immediately recalls the image of the lunar territory. The rotation on a vertical axis of a 'stand-in' placed on the back of the diffuser allows to obtain evocative moon's phases, producing different light projections. The interaction between the product and its user allows to obtain evocative, magical atmospheres.







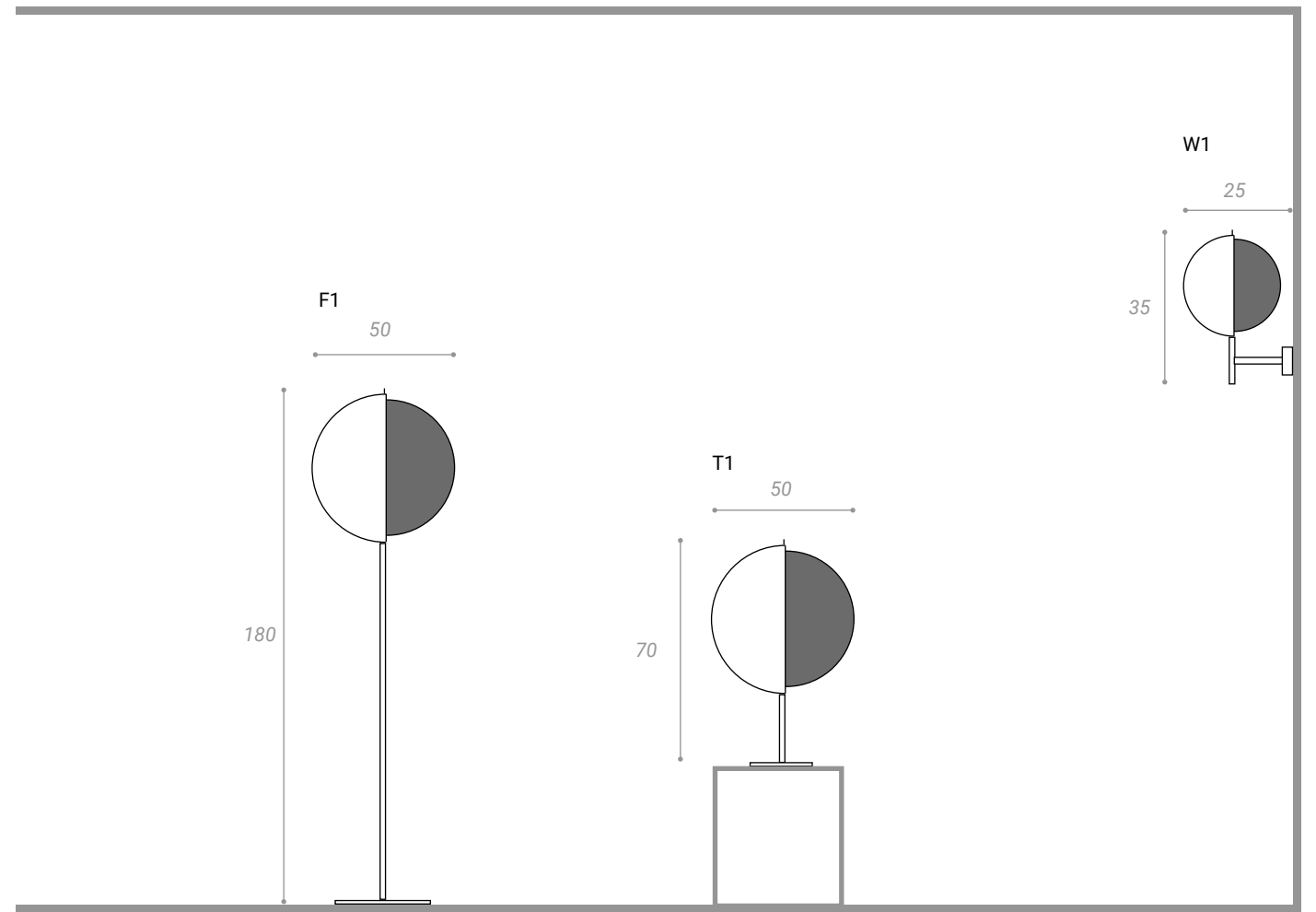

MATERIALI/  
MATERIALS



FIBRA DI VETRO/  
FIBERGLASS 



FINITURE/  
FINISHES

BRONZO/  
BRONZE 

OTTONE/  
BRASS 

RAME/  
COPPER 

F1 E27   
T1 E27   
W1 E14 

  F1/T1 Dimmer included  
  W1 

# HULA-HOOP

design Gianfranco Marabese 2021

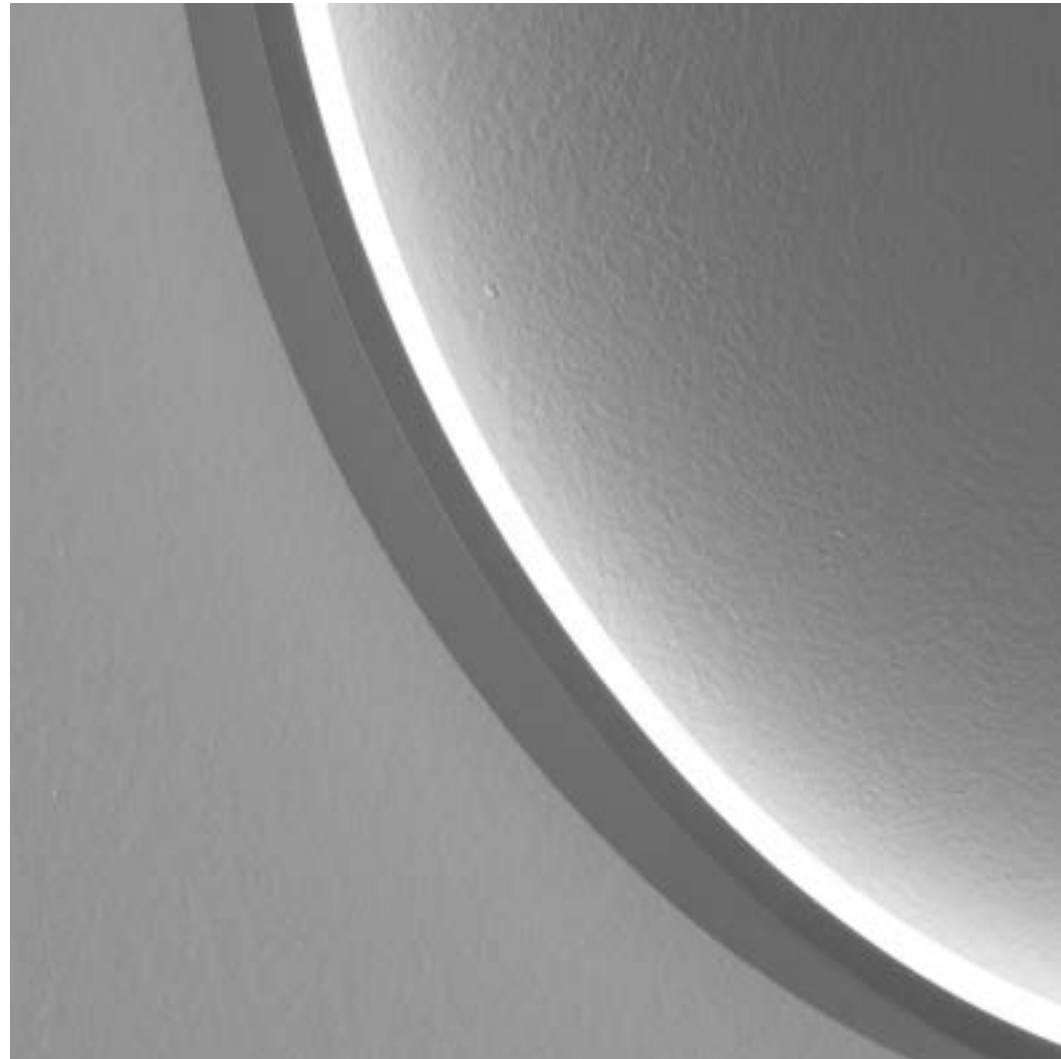

Cerchi in metallo circoscrivono un anello luminoso che irradia di luce l'interno del perimetro, diffondendola morbidamente nell'ambiente. La leggerezza e la perfezione della forma, che sembra galleggiare sulle superfici che l'accolgono, fanno di Hula-Hoop un elemento di luce facilmente inseribile nei contesti più diversi.

Metal circles surround a luminous ring that radiates light inside the perimeter, spreading it softly in the environment. The lightness and the perfection of the shape, which seems to float on the surfaces that welcome it, make Hula-Hoop a lighting tool that can be easily inserted into a variety of diverse contexts.



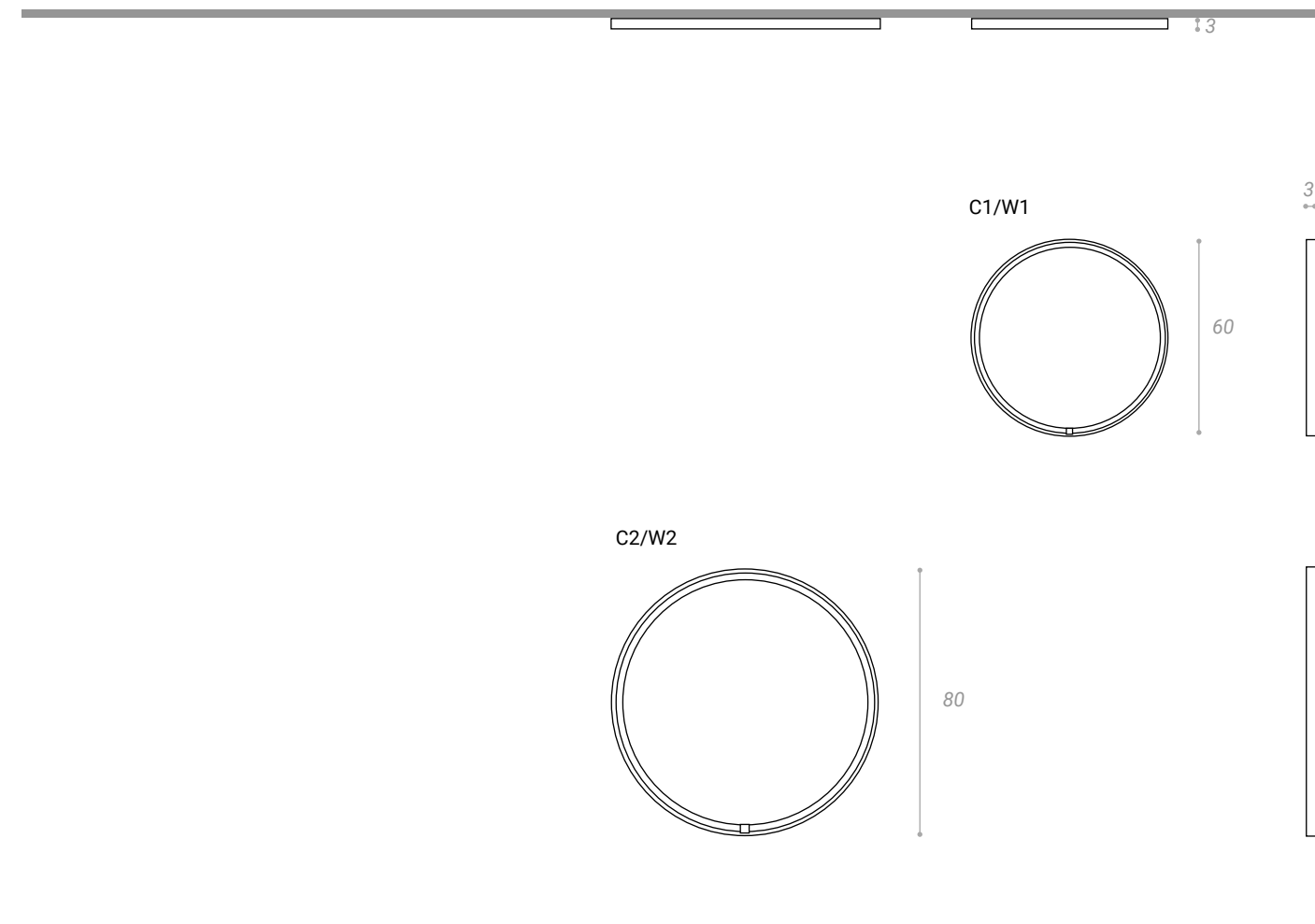

C1/W1 Led 24V 23W 2280Lm 3000°K  
 C2/W2 Led 24V 30W 3000Lm 3000°K

Remote driver

MATERIALI/MATERIALS  
 alluminio/aluminium

FINITURE/  
 FINISHES

BRONZO/  
 BRONZE

OTTONE/  
 BRASS

RAME/  
 COPPER





# MAMAMIA

design Gianfranco Marabese 2003

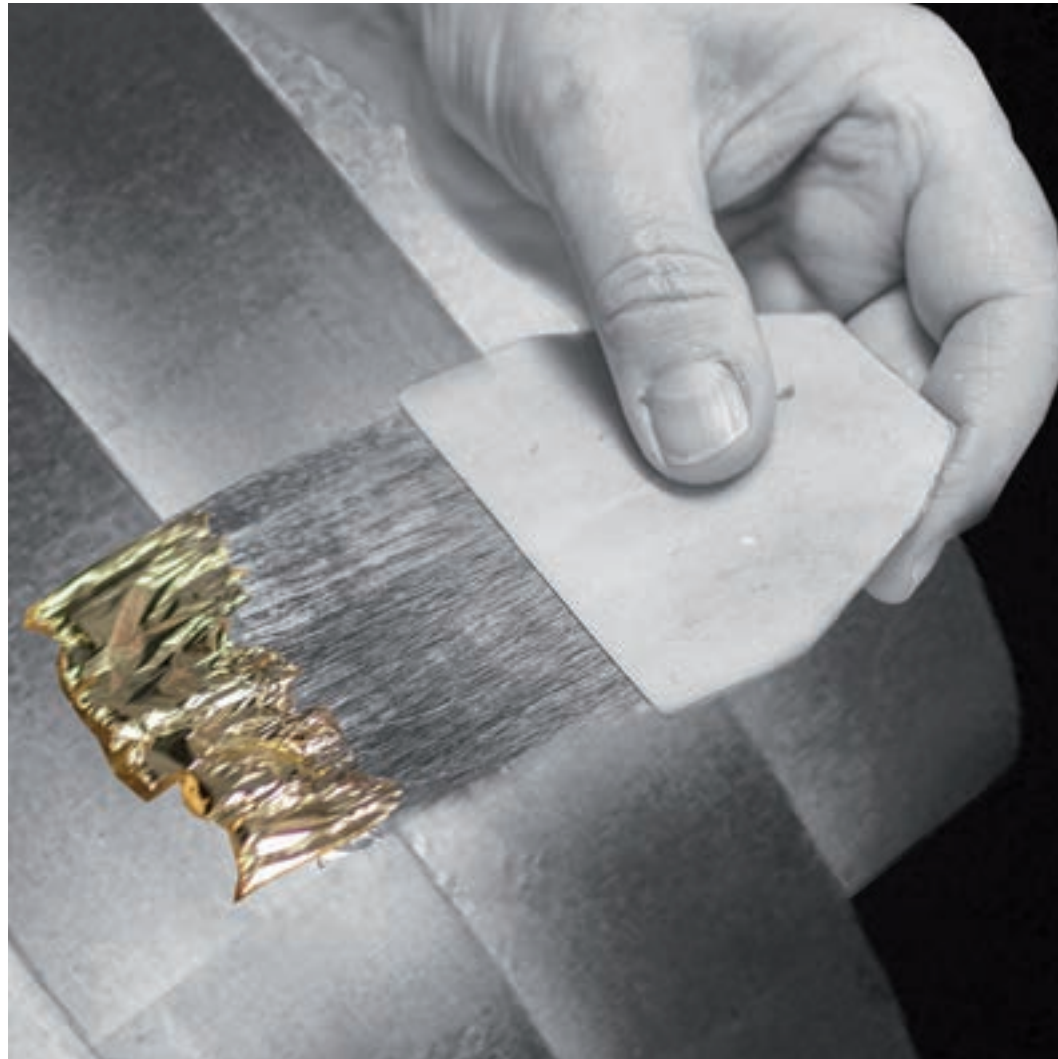

Collezione che riprende ed attualizza formalmente, segni distintivi del design nordico, unendoli ad atmosfere di sapore orientale. Nove anelli in metallo di misure diverse formano un diffusore con fonte luminosa interna netta e precisa, che genera sulle superfici effetti e riflessi suggestivi.

Collection that takes up and updates formally, distinctive signs of nordic design, combining them with an oriental taste. Nine metallic rings with different diameters make up the shade with light source inside, that creates suggestive effects and reflexes.













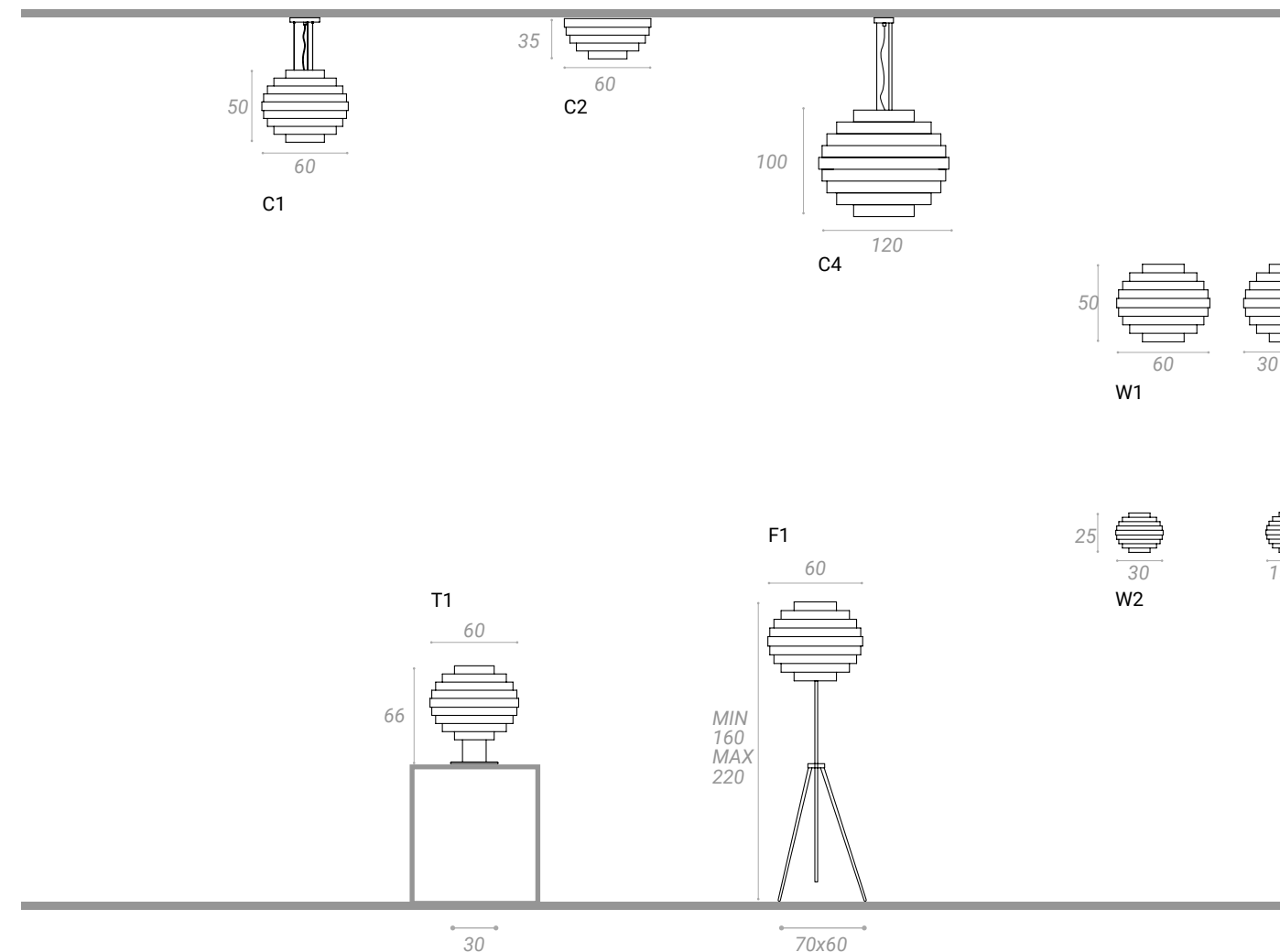

MATERIALI/MATERIALS  
metallo/metal

FINITURE/  
FINISHES

ALLUMINIO/  
ALUMINIUM

BIANCO/  
WHITE

BRONZO FOGLIA RAME/  
BRONZE COPPER LEAF

FOGLIA ARGENTO/  
SILVER LEAF

FOGLIA ORO/  
GOLD LEAF

FOGLIA RAME/  
COPPER LEAF

NERO ALLUMINIO/  
BLACK ALUMINIUM

- C1 E27 20W 2500Lm
- C2 E27 20W 2500Lm
- C4 3x E27 20W 2500Lm (7500Lm)
- W1 2x E27 20W 2500Lm (5000Lm)
- W2 LinearLED R7s 80mm 7W 800Lm
- F1 3x E27 20W 2500Lm (7500Lm)
- T1 E27 20W 2500Lm

C1/C2/C4/W1/W2 Dimmer included  
 F1/T1

# SKYFALL

design Gianfranco Marabese 2016



Collezione di lampade con diffusore realizzato in lamiera di ottone, lavorata secondo l'antica arte della battitura a mano, che rende pregiata e carica di vibrazioni uniche, la superficie del disco.

Lamp's collection with diffuser made in handmade hammered brass plate, which makes precious and full of unique vibrations the disc's surface.







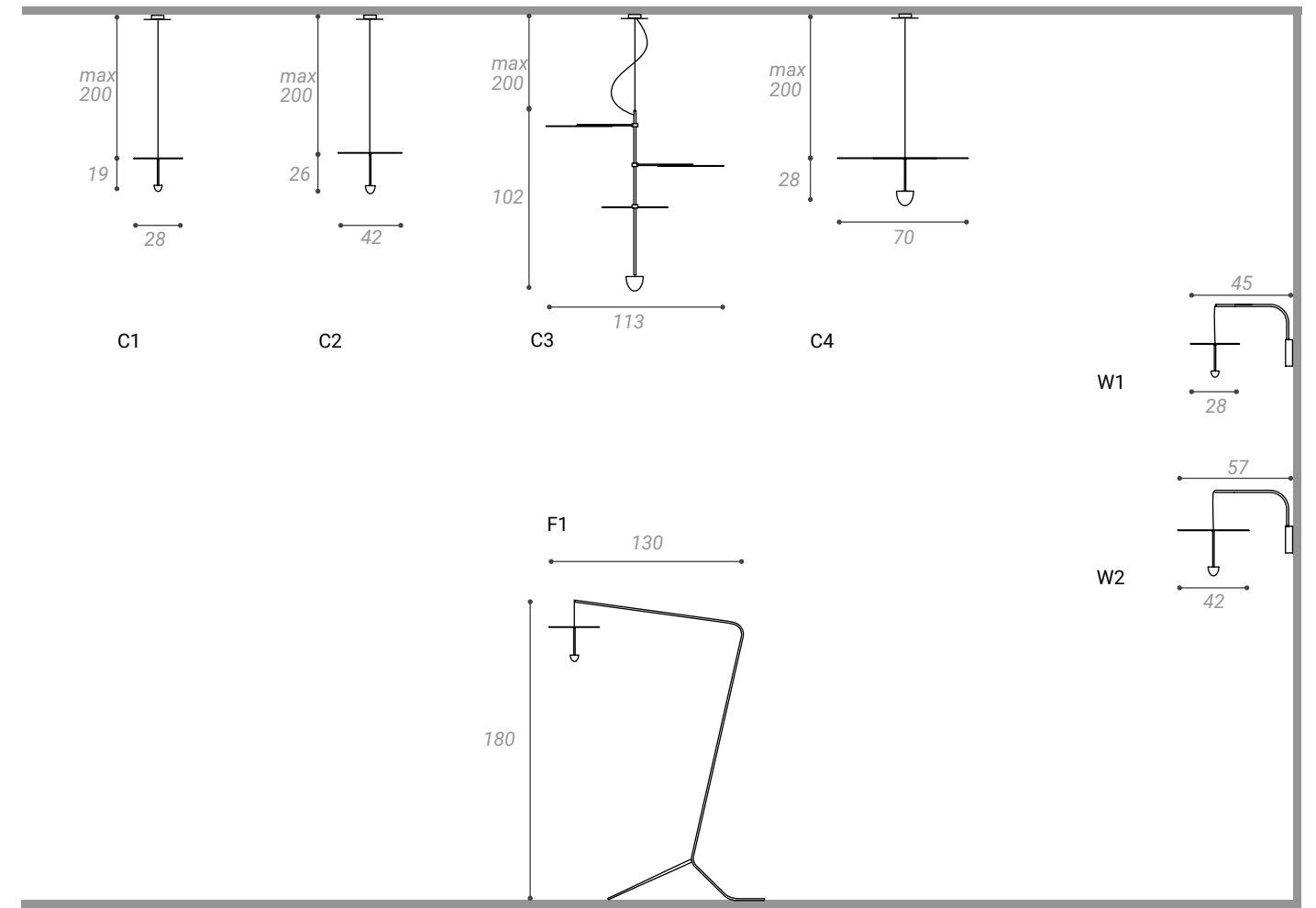

- C1 } Led 13W 110/230V 1000Lm 3000°K
- C2 } Led 13W 110/230V 1000Lm 3000°K
- C3 } Led 17W 110/230V 1350Lm 3000°K
- C4 } Led 17W 110/230V 1350Lm 3000°K
- W1 } Led 13W 110/230V 1000Lm 3000°K
- W2 } Led 13W 110/230V 1000Lm 3000°K
- F1 }



F1  
C1/C2/C3/C4/W1/W2

Dimmer included



MATERIALI/MATERIALS  
metallo/metal

FINITURE/  
FINISHES

OTTONE/  
BRASS





# LIBERA

design Gianfranco Marabese 2016



Lantern in tre dimensioni, con fonte luminosa ad effetto galleggiante grazie al suo posizionamento all'interno del sottile perimetro di metallo, che ne definisce la forma.

Lantern in three dimensions, with a floating effect light source thanks to its positioning inside the thin metallic perimeter, which defines its shape.



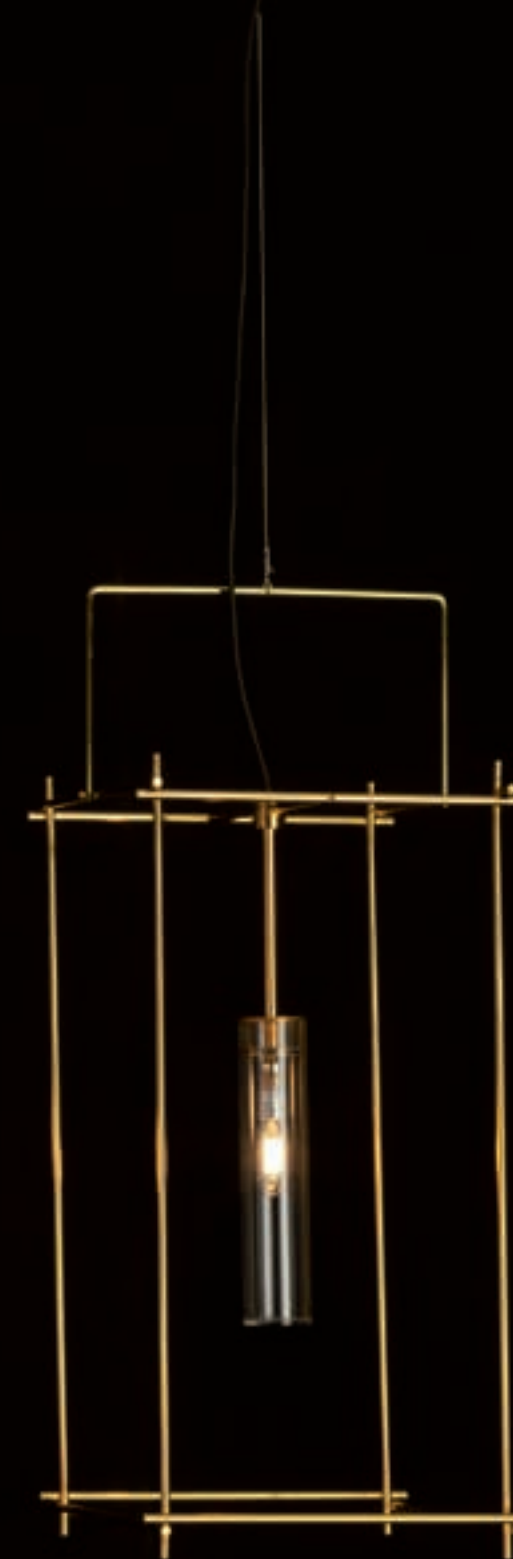

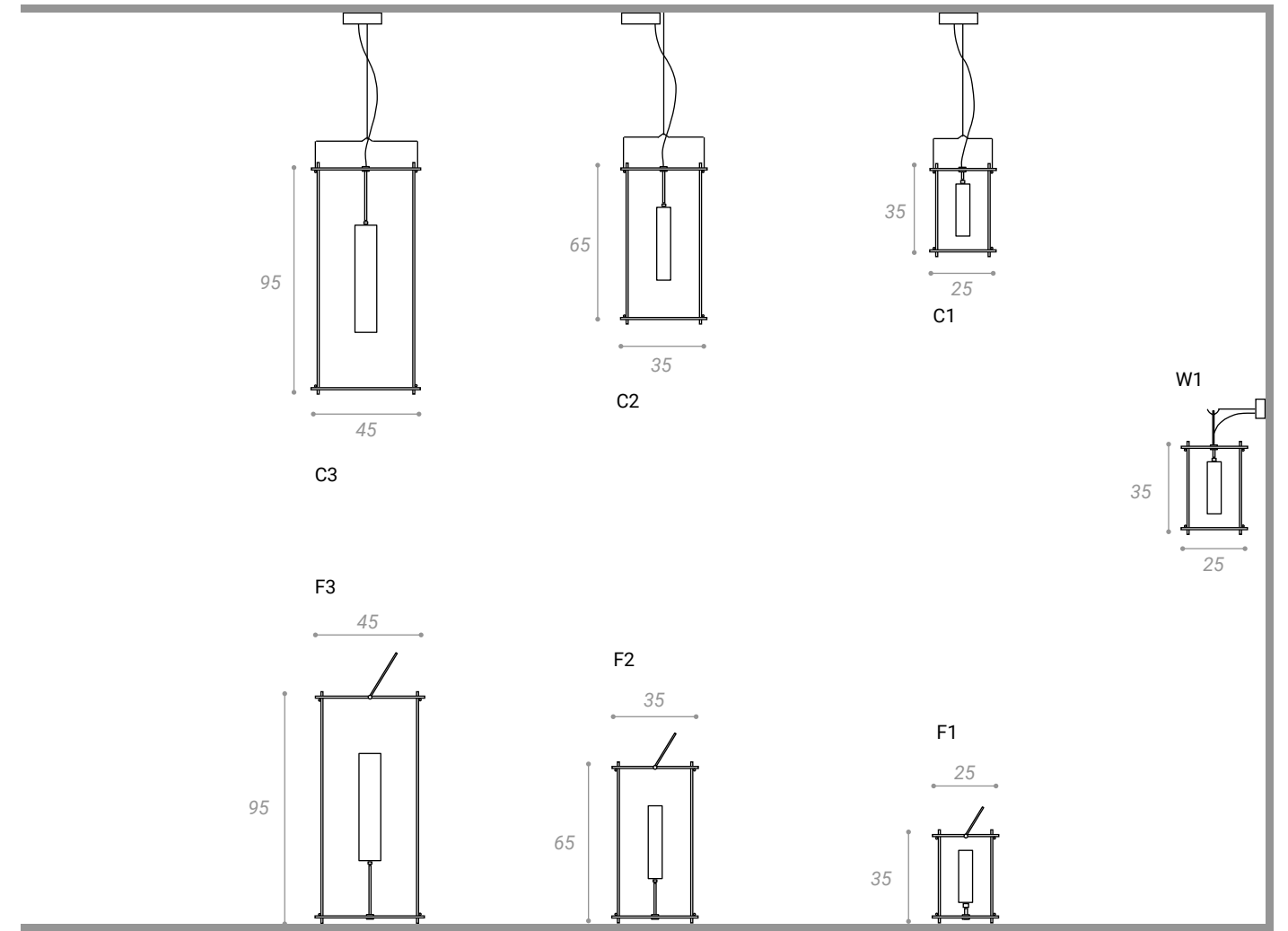

- C1 } E14 5W 800Lm
- C2 } E14 5W 800Lm
- C3 } E27 20W 2500Lm
- F1 } E14 5W 800Lm
- F2 } E14 5W 800Lm
- F3 } E27 20W 2500Lm Dimmer included
- W1 } E14 5W 800Lm

CE F1/F2/F3  
 CE C1/C2/C3/W1

MATERIALI/MATERIALS  
 metallo/metal

FINITURE/  
 FINISHES

BIANCO/  
 METAL

BRONZO/  
 BRONZE

OTTONE/  
 BRASS

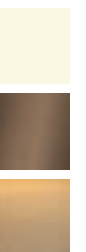



# LETTURA

design Gianfranco Marabese 2015/2017

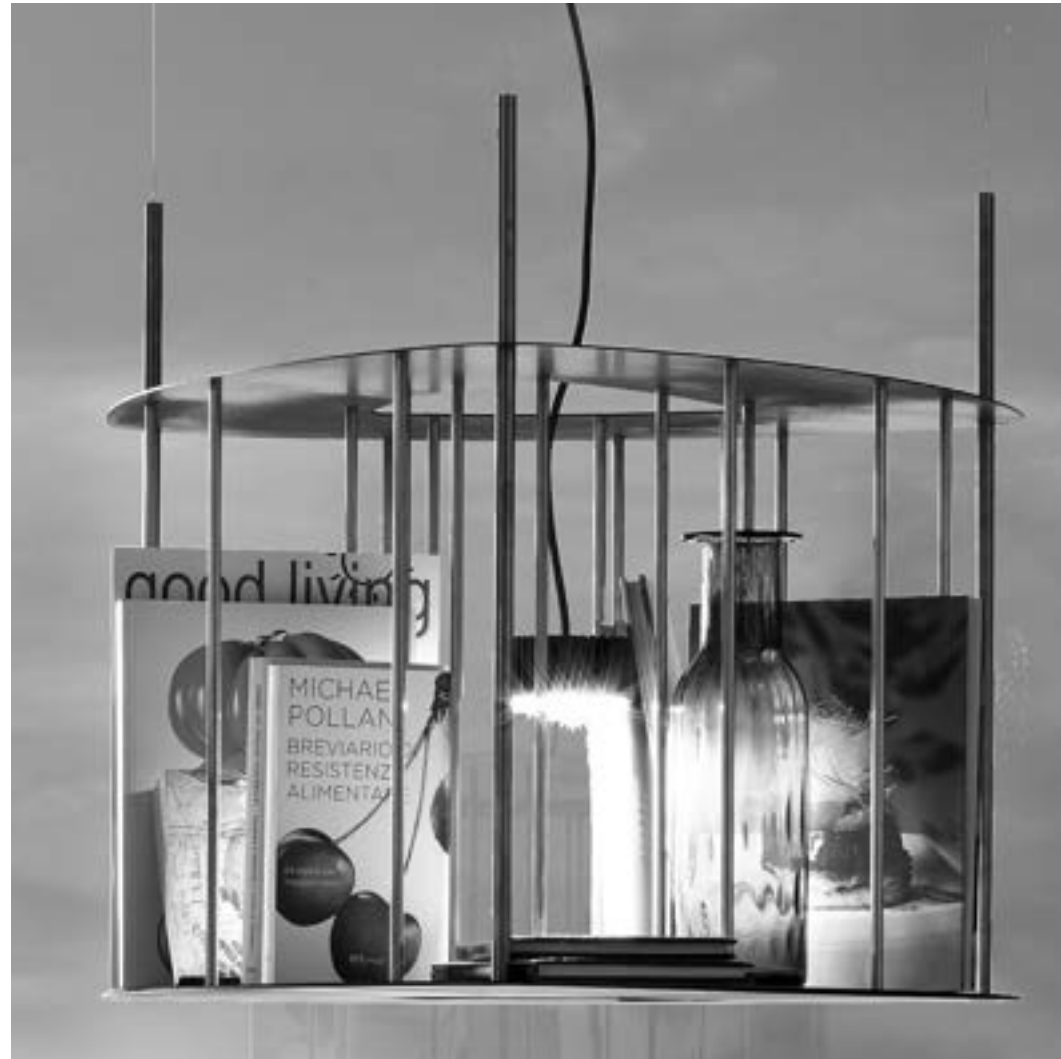

Collezione che affronta il tema della 'lettura' in modo inedito e funzionale. una sottile ma robusta struttura in metallo, accessibile a 360°, realizza originali librerie luminose.

Collection that addresses the theme of "reading" in a new and functional way: the thin but sturdy metal structure, accessible at 360°, creates original luminous bookcases.



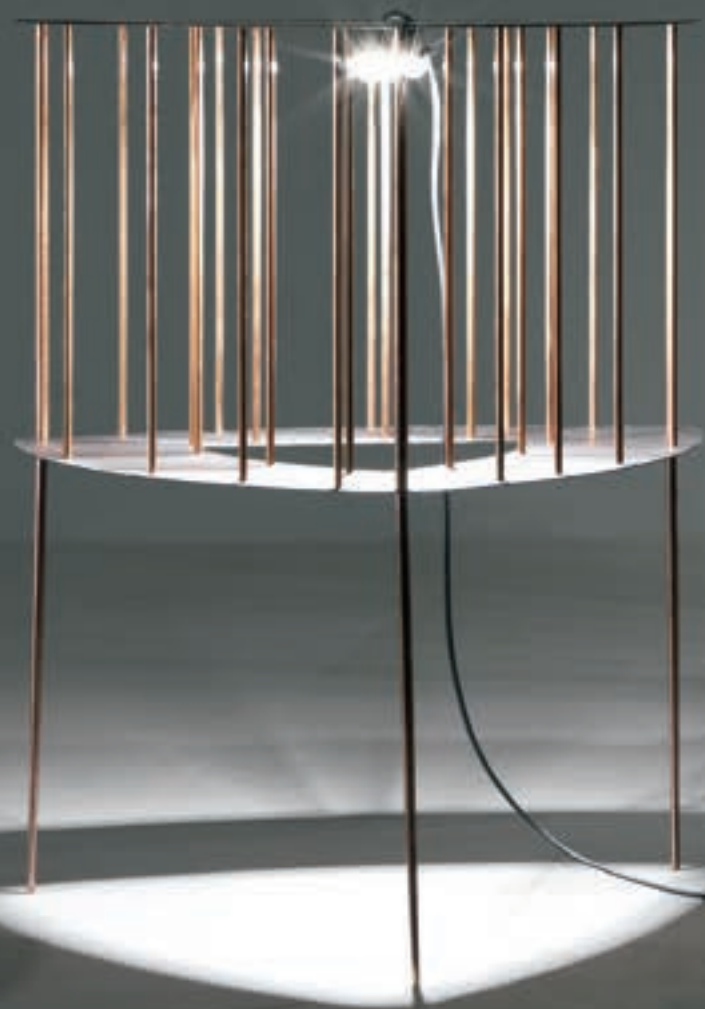



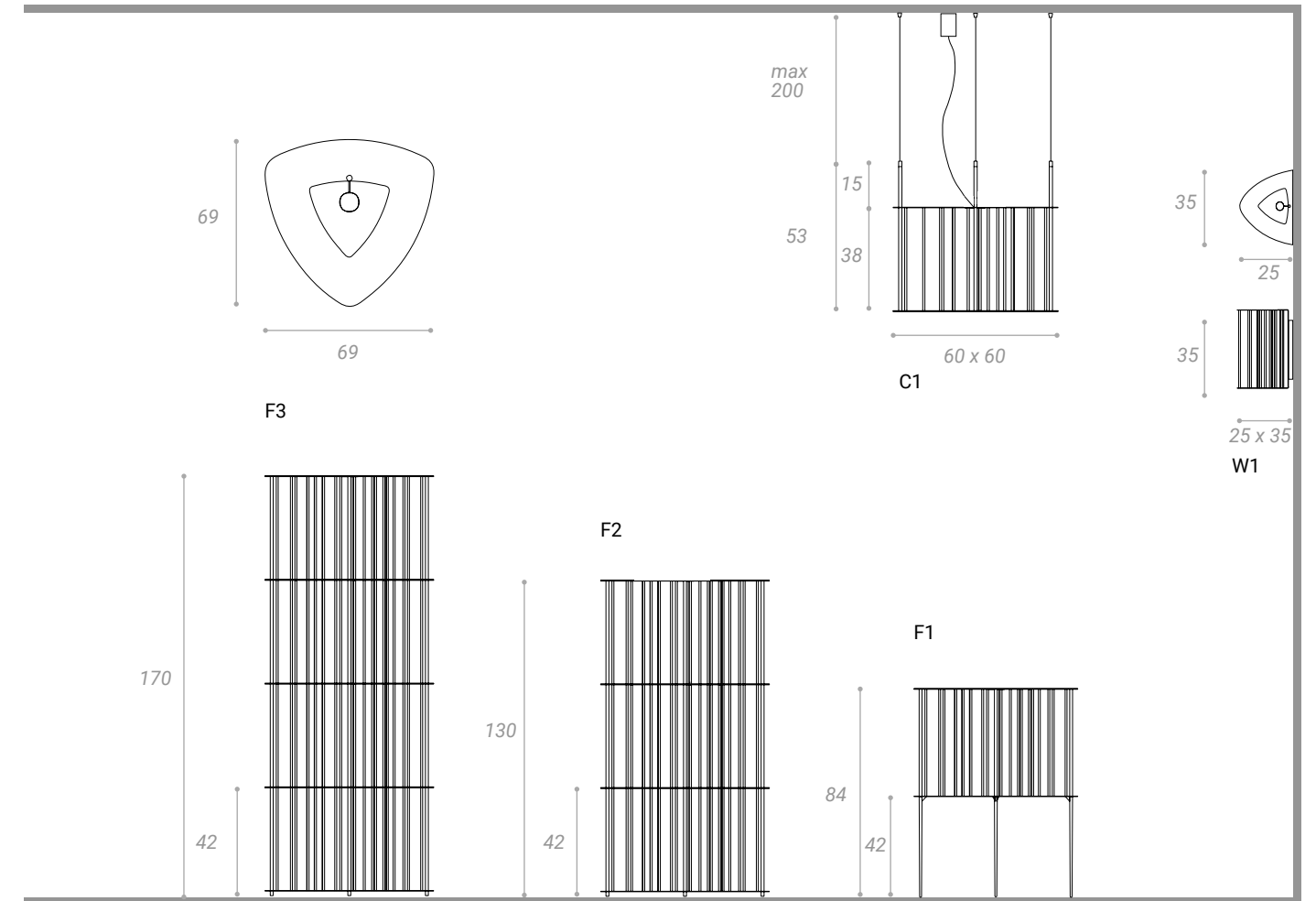

- W1 Led 110/230V 4,5W 450Lm 3000°K
- C1 Led 110/230V 17W 1350Lm 3000°K
- F1 } Led 110/230V 17W 1350Lm 3000°K
- F2 } Dimmer included
- F3 }



Dimmer included



MATERIALI/MATERIALS  
metallo/metal

FINITURE/  
FINISHES

OTTONE/  
BRASS

RAME/  
COPPER



# PENELOPE

design Sebastiano Tosi 2017



Un intreccio armonico e preciso di fili metallici, forma una sfera leggera e trasparente, che dà vita ad una collezione di lampade, a luce diretta ed indiretta.

A harmonious and precise weaving of metal wires, forming a light and transparent sphere, that gives life to a collection of lamps, with direct and indirect light.







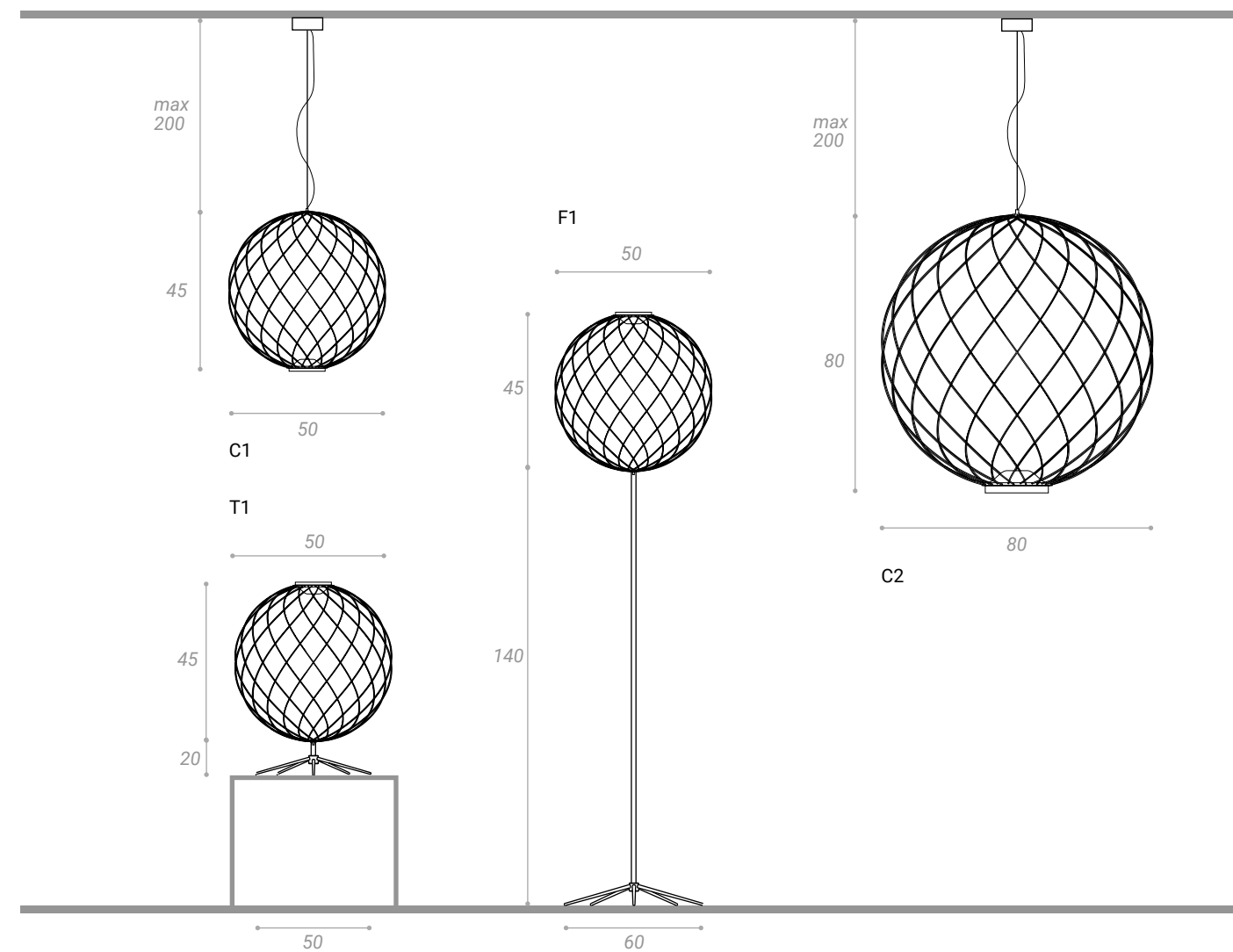

C1 }  
 C2 } luce diretta/ direct light: Led 17W 110/230V 1350Lm 3000°K  
 F1 } luce indiretta/ indirect light: Led 4,5W 110/230V 450Lm 3000°K  
 T1 }

CE ⊕ ⚡ ⚡ ⚡ C1/C2 ⚡ ⚡ ⚡ Dimmer included  
 CE ⊕ ⚡ ⚡ ⚡ T1/F1 ⚡ ⚡ ⚡

MATERIALI/MATERIALS  
 metallo/metal

FINITURE/  
 FINISHES

BIANCO \  
 WHITE

BRONZO/  
 BRONZE

OTTONE/  
 BRASS

NERO/  
 BLACK



# PENOMBRA

design Sebastiano Tosi 2014



Collezione di lampade con parabola riflettente a fuoco variabile. La luce del LED mette in evidenza preziose lavorazioni ed eleganti finiture opache.

Collection of lamps with reflecting parabolas. The LED light highlights precious workmanship and elegant matt finishes.

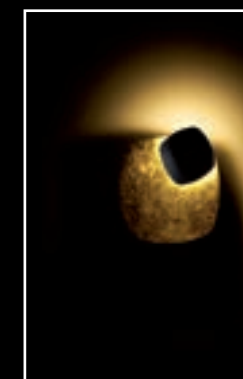
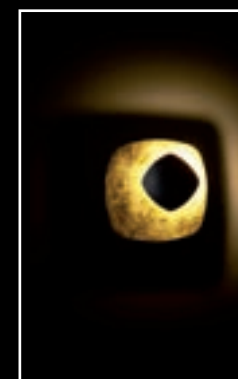
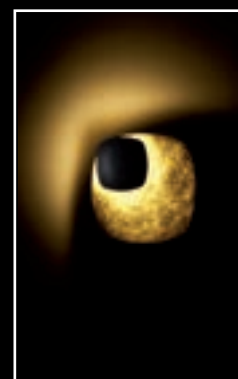





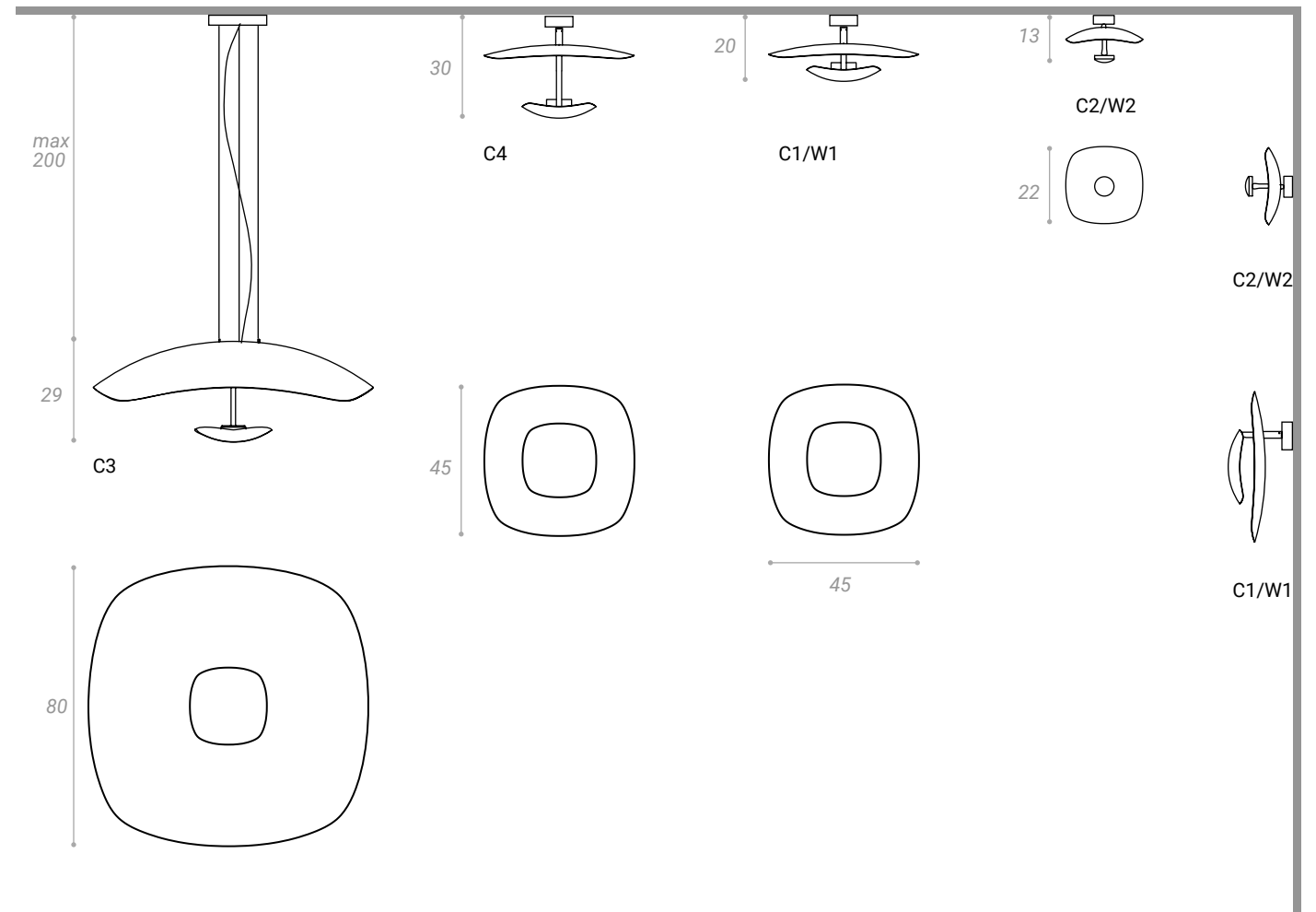

C3 }  
 C4 } Led 17W 110/230V 1300Lm 3000°k  
 W1/C1 }  
 W2/C2 } Led 4,5W 110/230V 450Lm 3000°k

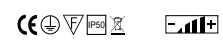

MATERIALI/MATERIALS  
 metallo/metal

FINITURE/  
 FINISHES

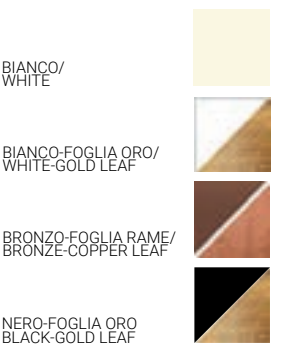

# COUPE'

design Bruno Umberto e Lorenzo Gecchelin 2023



Coupé' nasce per restituire agli ambienti un'illuminazione di potenza coniugando al meglio funzionalità ed estetica. Grazie alla tecnologia LED di ultima generazione, Coupé si trasforma in una fonte di luce per interni simile a quella prodotta dalle 'alogene' di un tempo, da cui eredita la poesia, l'intensità e il comfort luminoso, ma non i consumi. Il disegno pulito si caratterizza in un taglio obliquo che dona dinamicità al doppio corpo illuminante cilindrico.

Giving back powerful lighting to environments by combining functionality, aesthetics and emotion is the challenge taken up by Coupé'. Thanks to LED technology, Coupé is transformed into a source of light for interiors very similar to that produced by 'halogen' lamps of the past, from which it inherits poetry, power and luminous comfort, but not consumption. The clean design is characterized by an oblique cut that gives dynamism to the double cylindrical lighting body.









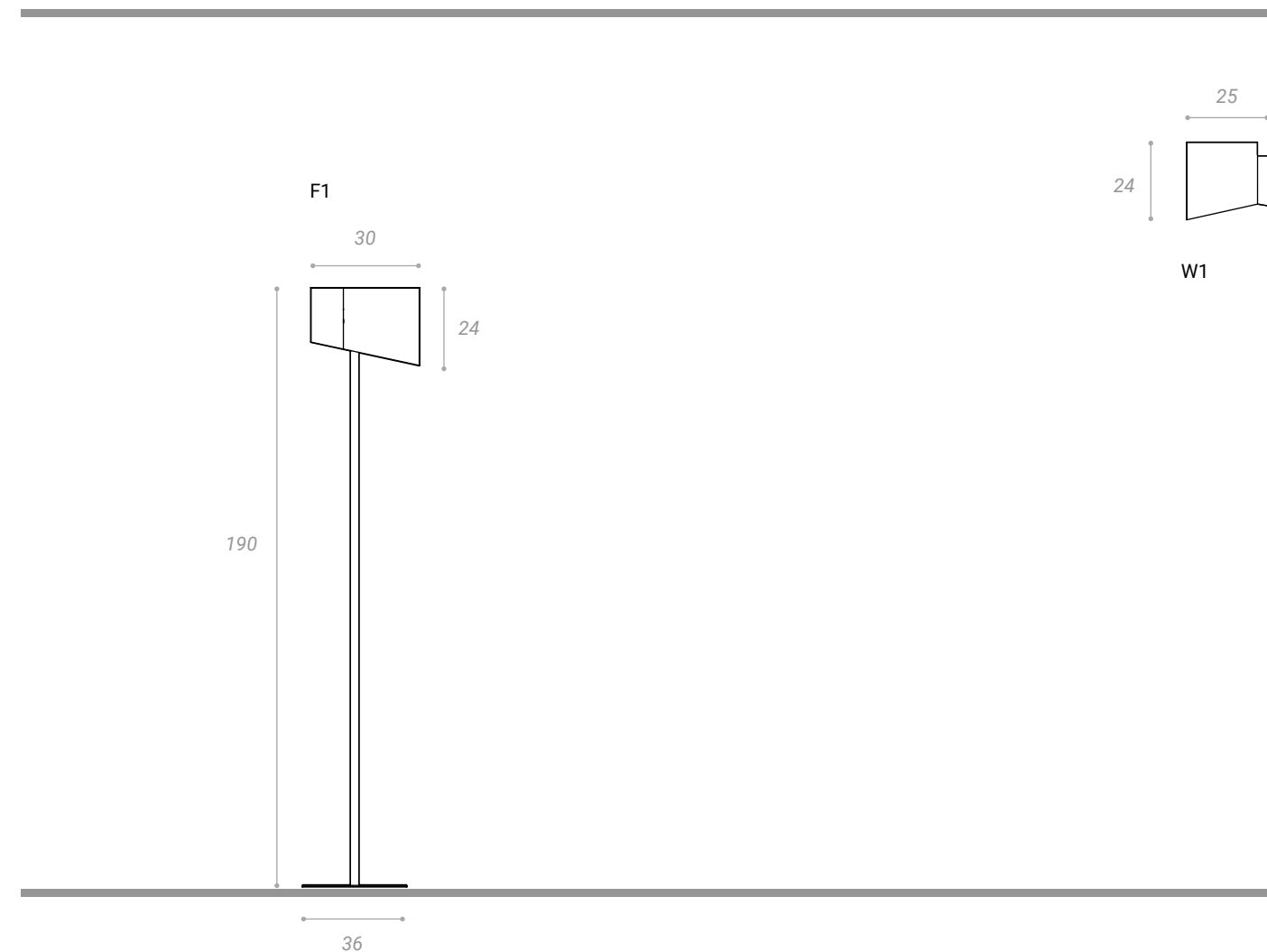

MATERIALI/MATERIALS  
metallo/metal

FINITURE/  
FINISHES

WHITE/  
BIANCO

OTTONE/  
BRASS

NERO/  
BLACK

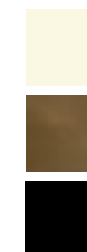

F1 3x E27 20W 2500Lm tot. 7500Lm + GU10 double ignition  
W1 3x E27 20W 2500Lm tot. 7500Lm



W1 Touch dimmer included  
F1 Touch dimmer included

# ARMONICA

design Gianfranco Marabese 2010



Proiettore snodabile per orientare la luce, di forma iconica, dai tratti essenziali, eleganti e un design senza tempo.

Flexible projector to orient the light, iconic in shape, with essential, elegant lines and a timeless design.

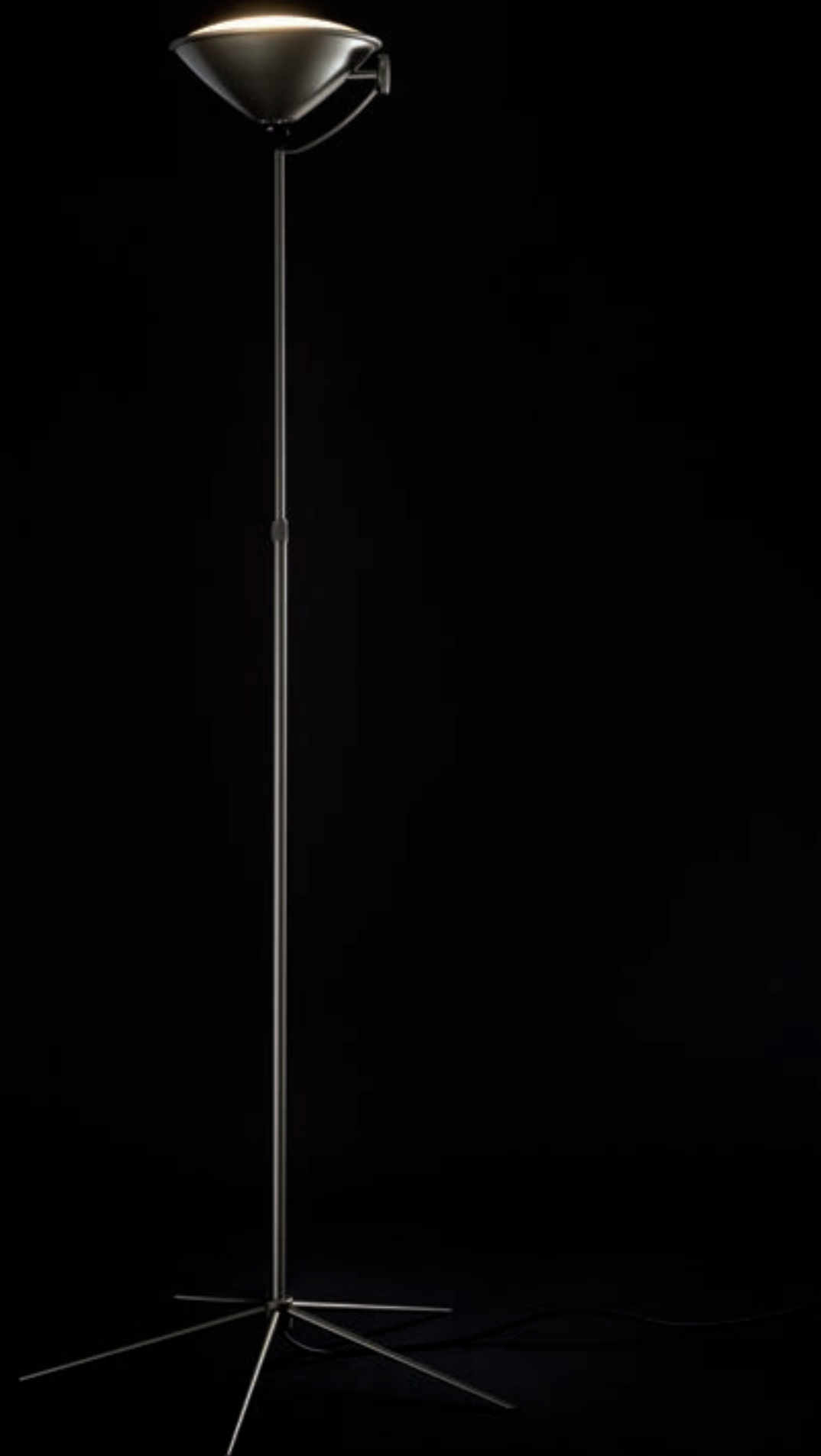





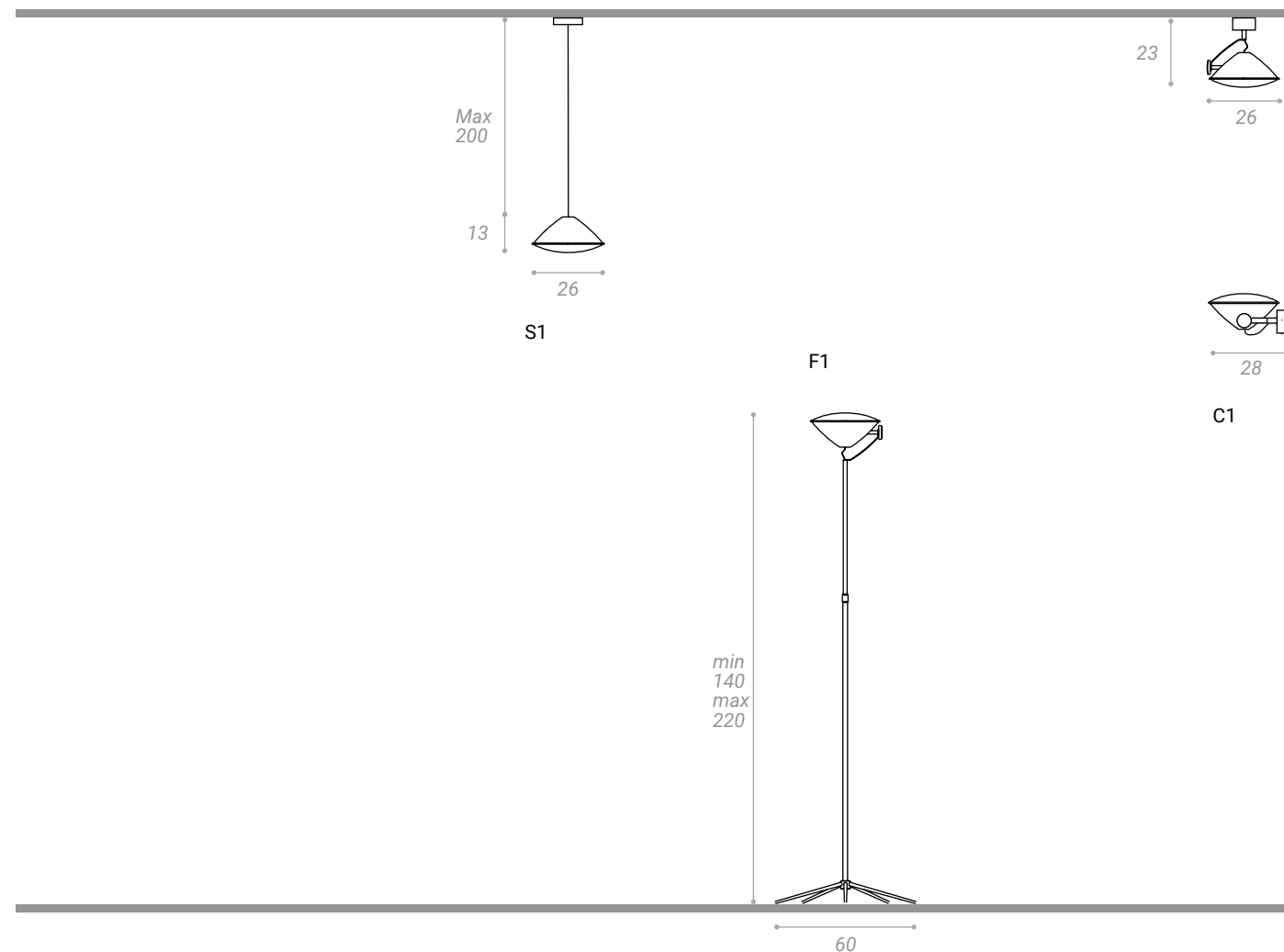

MATERIALI/MATERIALS  
metallo/metal

FINITURE/  
FINISHES

BRONZE/  
BRONZE

CROMO/  
CHROME

OTTONE/  
BRASS

RAME/  
COPPER



S1 ] LED R7s 118mm 17,5W 110/230V 2452Lm  
 C1 ] LED R7s 118mm 17,5W 110/230V 2452Lm  
 F1 ] LED R7s 118mm 17,5W 110/230V 2452Lm Dimmer included





# OPERA

design Bruno e Lorenzo Gecchelin 2019





Lampada da parete dal disegno elegante e dalle preziose finiture metalliche. La forma circolare, dolcemente curvata, avvolge la fonte luminosa permettendole di espandersi armonicamente

Wall lamp with an elegant design and precious metal finishes. The circular shape, gently curved, wraps the light source allowing it to expand harmoniously.



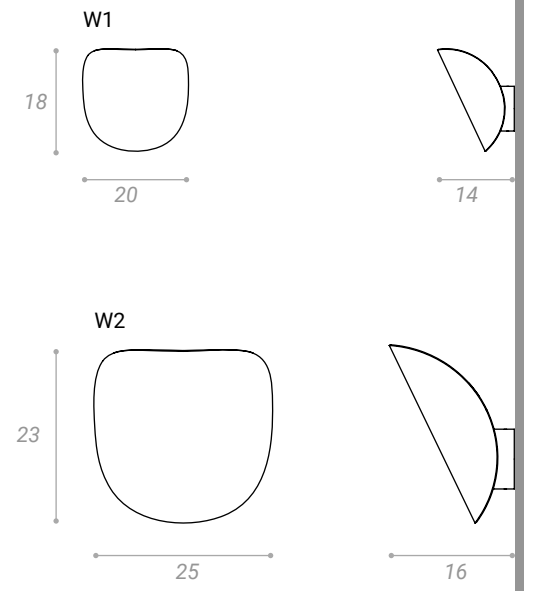



W1 Gu10 750Lm   
 W2 E27 2550Lm 



MATERIALI/MATERIALS  
metallo/metal

FINITURE/  
FINISHES

- BIANCO/  
WHITE 
- BRONZO/  
BRONZE 
- OTTONE/  
BRASS 
- RAME/  
COPPER 

# AURORA

design Gianfranco Marabese 2019

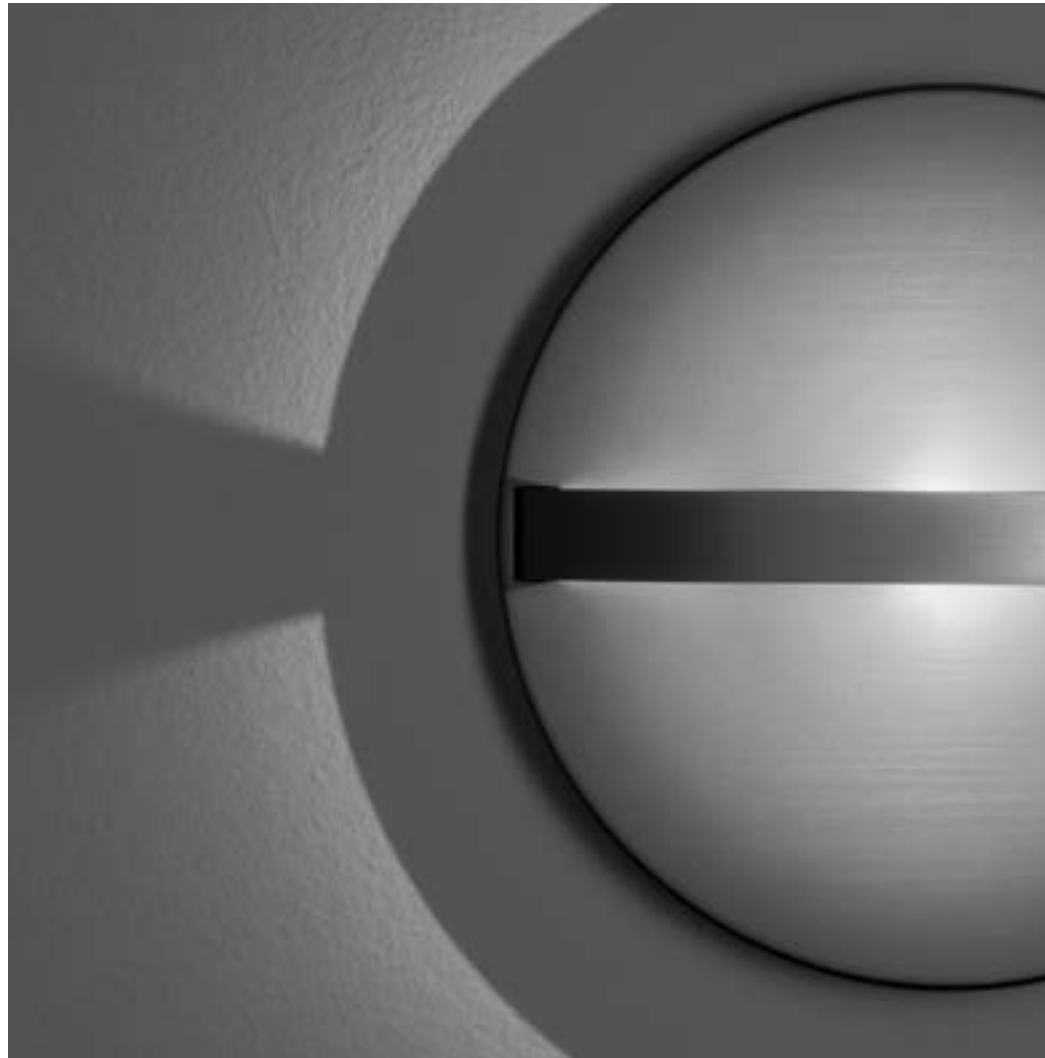

Lampada da parete e soffitto con cuore centrale luminescente. La fonte luminosa espande la luce in modo naturale diffondendo effetti cromatici affascinanti, che mutano a seconda della superficie riflettente, donando tonalità calde, confortevoli.

Wall and ceiling lamp with central luminescent core. The light source expands the light in a natural way spreading fascinating chromatic effects, which change depending on the reflecting surface, giving warm, comfortable tones.



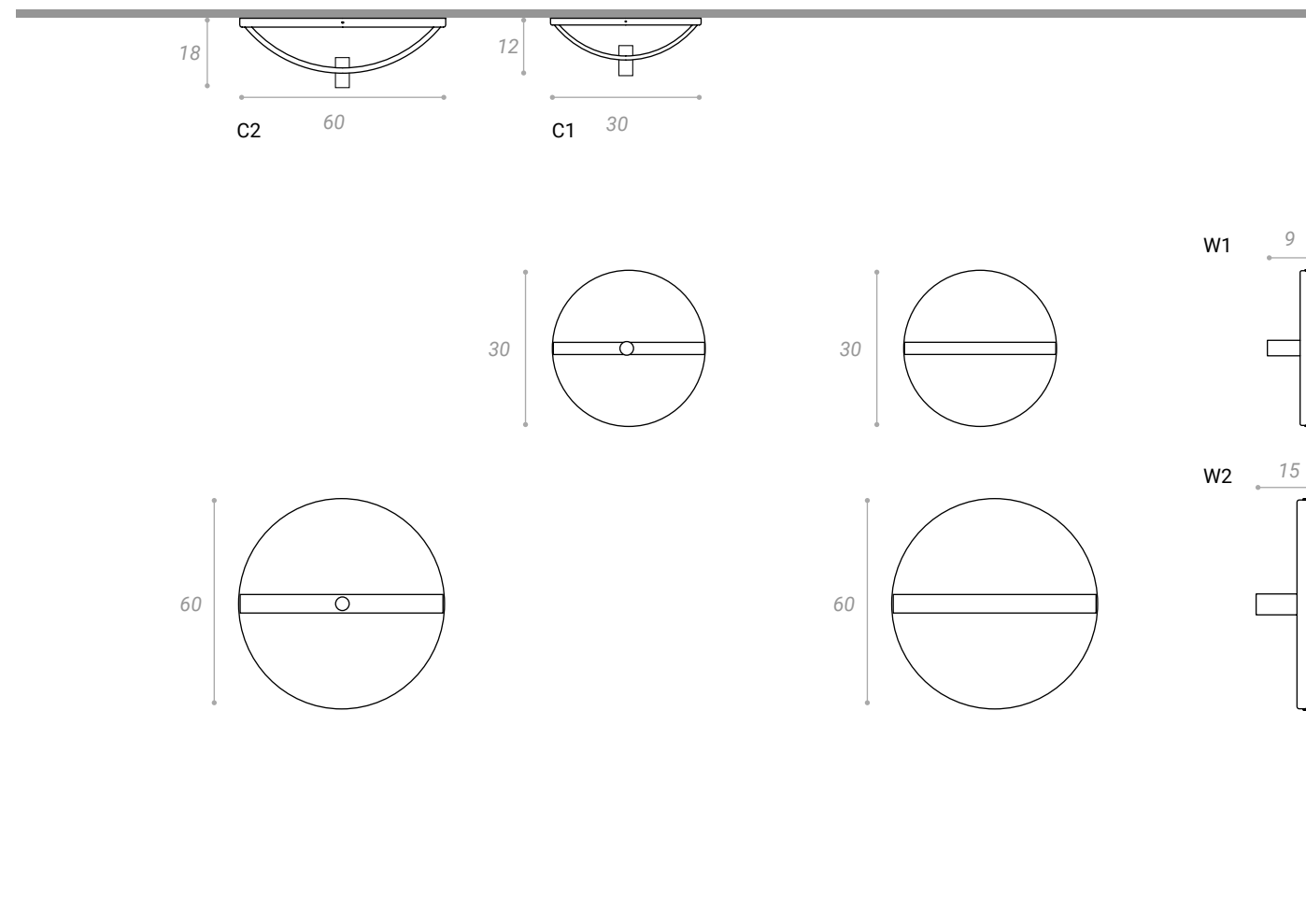

C1/C2 ] luce diretta/ direct light: Led 12W 350mA 1600Lm 3000°K  
 luce indiretta/ indirect light: Led 3W 350mA 300Lm 3000°K  
 W1     Led 6W 350mA 800Lm 3000°K  
 W2     Led 12W 350mA 1600Lm 3000°K



MATERIALI/MATERIALS  
 metallo/metal

FINITURE/  
 FINISHES

BIANCO/  
 WHITE

BRONZE/  
 BRONZE

OTTONE/  
 BRASS

RAME/  
 COPPER





# VOLO

design Lorenzo Gecchelin 2009

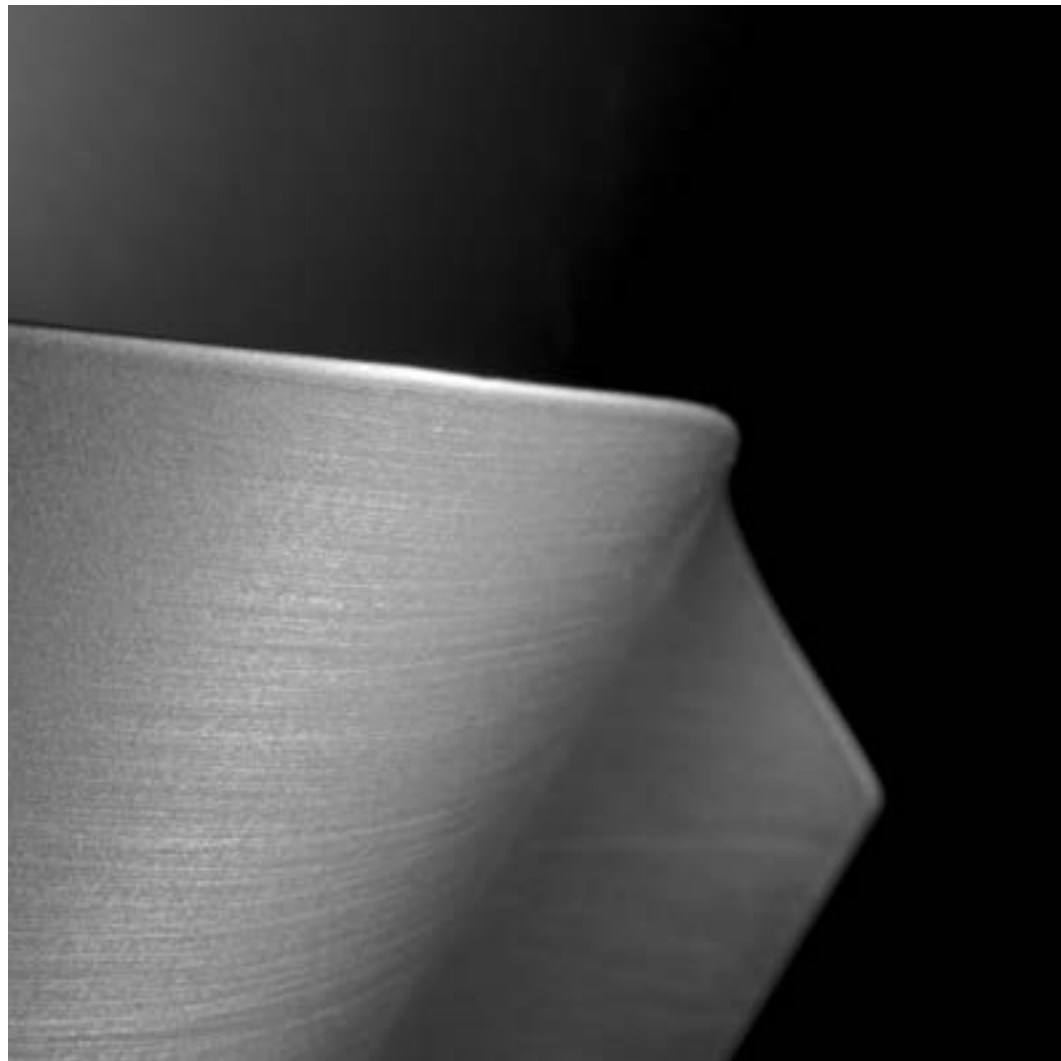

Lampada da parete dal disegno essenziale ed elegante: un foglio di metallo che curva sui due lati avvicinandosi alla parete.

Wall lamp with an essential and elegant design: a metal sheet that curves on both sides as it approaches the wall.



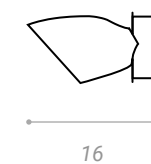
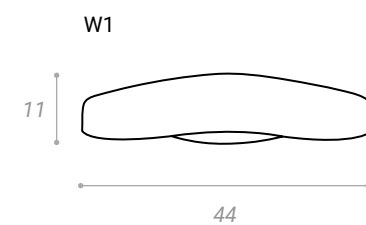

MATERIALI/MATERIALS  
metallo/metal

FINITURE/  
FINISHES

BIANCO/  
WHITE

BRONZO/  
BRONZE

OTTONE/  
BRASS

RAME SATINATO/  
SATINATED COPPER



W1 E27 20W 2500Lm

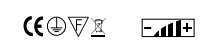



# CINEMÀ

design Gianfranco Marabese 2014



Collezione che si ispira alle lampade utilizzate nei set cinematografici. Proiettori LED illuminano l'interno dei diffusori orientabili, che restituiscono luce riflessa senza abbagliare.

Collection inspired by the lamps used in movie sets. LED headlamps illuminate the inside of the adjustable diffusers that return reflected light without dazzling.















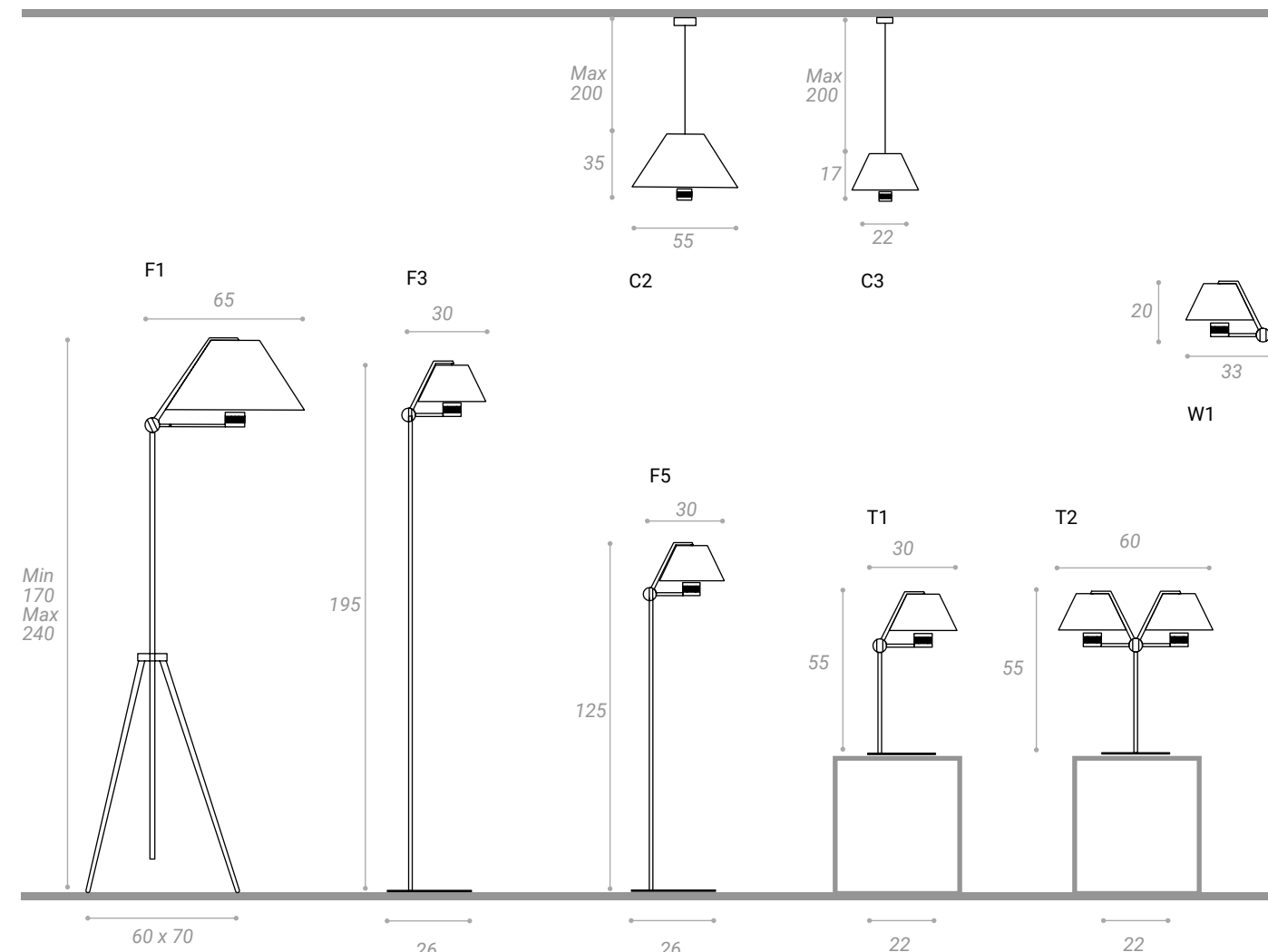









- F1 Led 17W 110/230V 1300Lm 3000°k Dimmer included
- C2 Led 17W 110/230V 1300Lm 3000°k 
- C3 Led 13W 110/230V 1000Lm 3000°k 
- W1 2x Led 13W 110/230V 1000Lm 3000°k Dimmer included
- T1
- T2
- F3 Led 13W 110/230V 1000Lm 3000°k Dimmer included
- F5

MATERIALI/MATERIALS  
metallo/metal

FINITURE/  
FINISHES

- ALLUMINIO/  
ALUMINIUM 
- BIANCO/  
WHITE 
- BIANCO-FOGLIA ORO/  
WHITE GOLD LEAF 
- BRONZO-FOGLIA RAME/  
BRONZE COPPER LEAF 
- NERO-FOGLIA ORO/  
BLACK GOLD LEAF 



# VIVAEDISON

design Gianfranco Marabese 2015



La lampadina di memoria si trasforma in un grande diffusore di luce in vetro borosilicato. Le importanti dimensioni sono state spinte fino al limite della fattibilità tecnica: per un risultato formale sorprendente e una luce confortevole.

The memory light bulb turns into a large borosilicate glass light diffuser. The great dimensions have been pushed to the limit of technical feasibility: for a surprising formal result and a comfortable light.









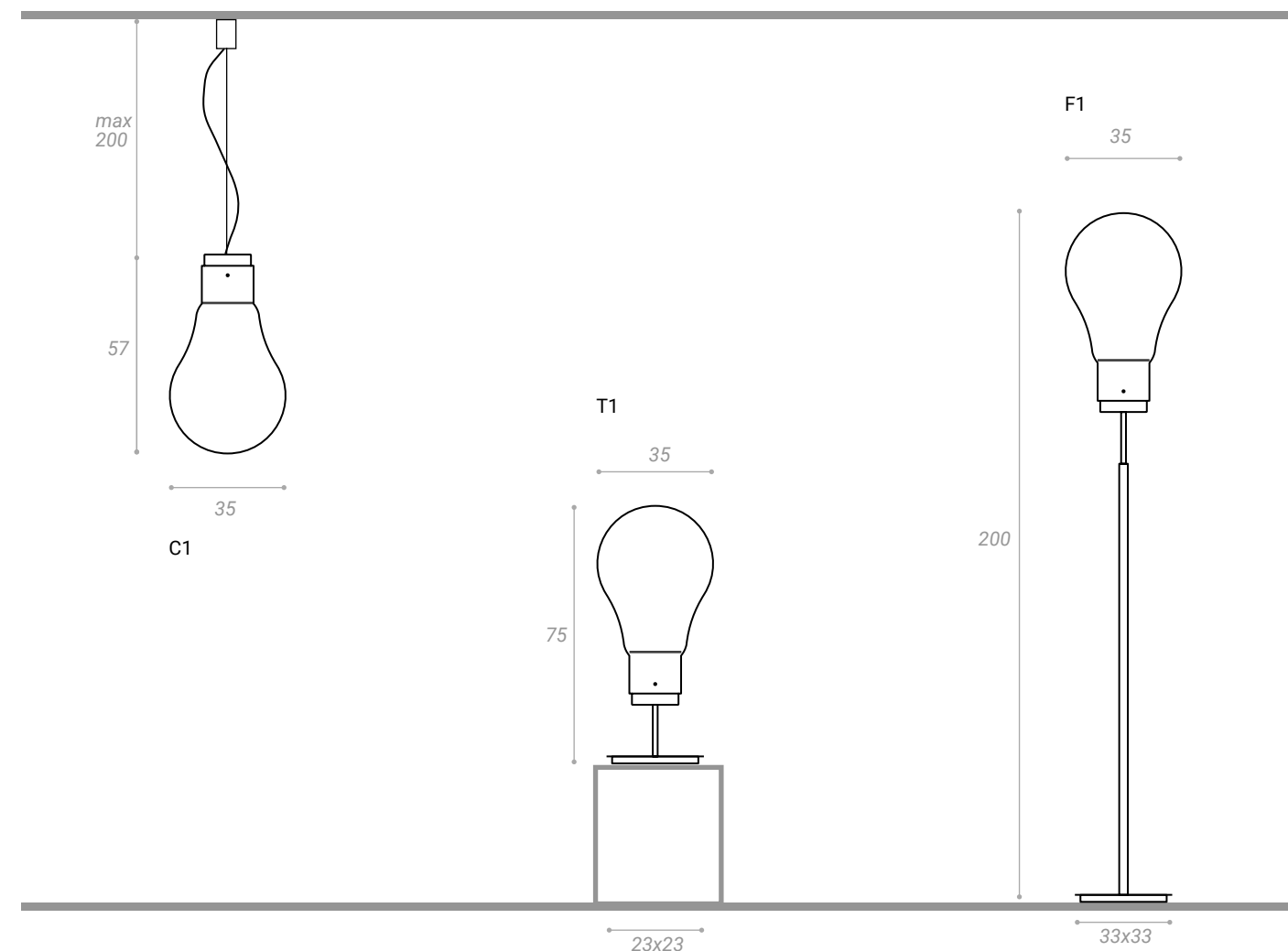



C1 GU10 R111 20W 220/240V 1580Lm   
 F1 } GU10 R111 20W 220/240V 1580Lm   
 T1 }

Dimmer included leather-covered base

MATERIALI/MATERIALS  
metallo/metal

FINITURE/  
FINISHES

BRONZO/  
BRONZE

OTTONE/  
BRASS



# KAJ

design Akamine Hidetoshi 1994/2021



Kaj, iconico prodotto degli anni '90 che trova ispirazione nell'origami: l'arte giapponese di creare figure da fogli di carta esclusivamente mediante la piegatura. E' infatti un foglio, ma in policarbonato, con 59 pieghe a dare vita alla sua forma: un disegno purissimo e una linea elegante, che avvolge la fonte luminosa.

Kaj, an iconic product from the 1990s, finds inspiration in origami: the Japanese art of creating figures by exclusively folding sheets of paper. It is in fact a polycarbonate sheet with 59 folds to give life to its shape: a very pure design and elegant line, which envelops the light source.







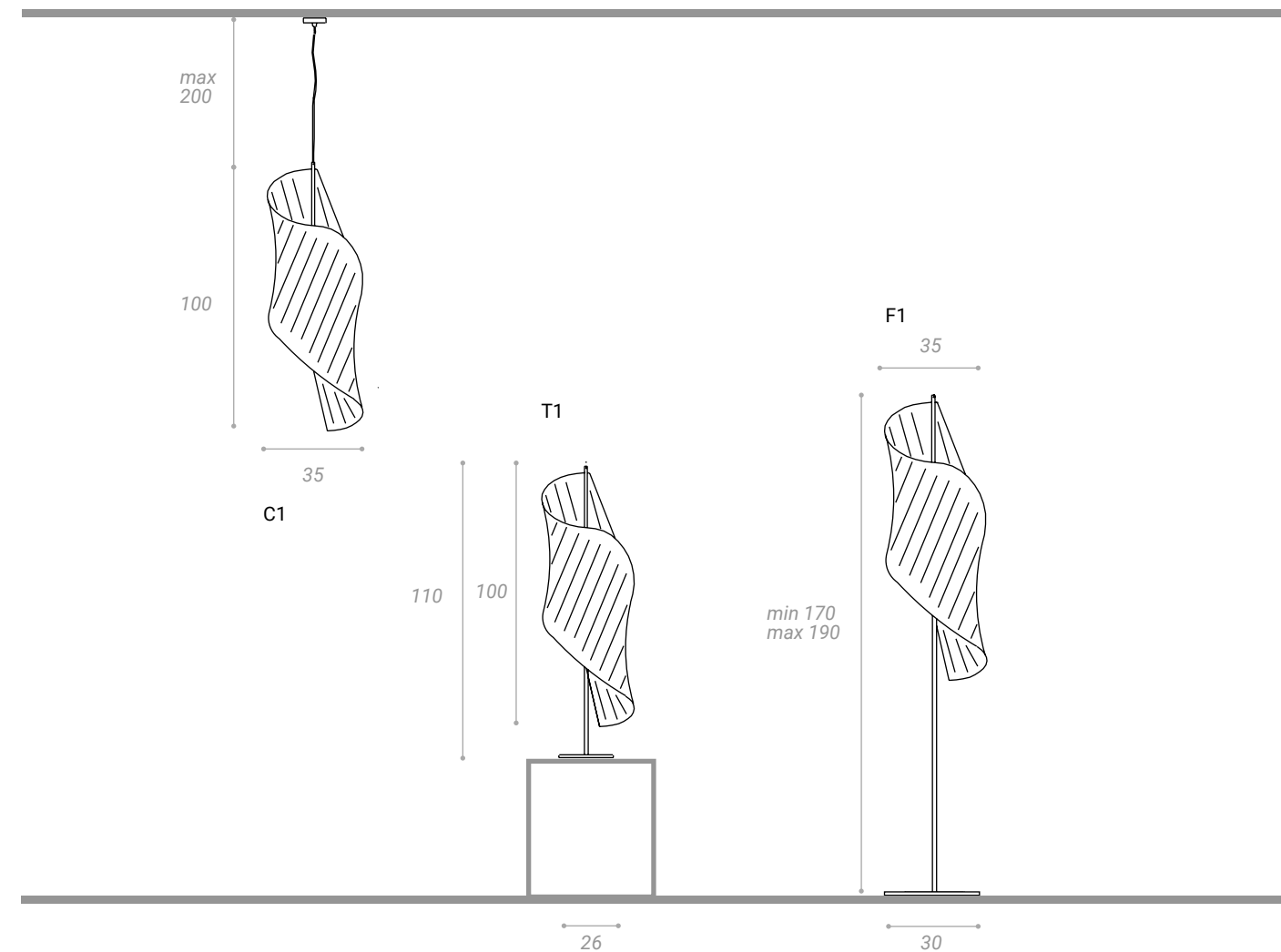

MATERIALI/MATERIALS  
 policarbonato/policarbonate  
 metallo/metal

FINITURE/  
 FINISHES

POLICARBONATO BIANCO/  
 WHITE POLYCARBONATE

BRONZO CHIARO/  
 LIGHT BRONZE



C1 }  
 F1 } E27 20W 2500Lm  
 T1 }

CE ENEC C1  
 CE RoHS F1/T1 Dimmer included



# DOLCEVITA

design Gianfranco Marabese 2011



Lampada da terra con diffusore in Tyvek® trasformabile. Attraverso la libera manipolazione, è possibile modellare e variare le dimensioni in altezza: personalizzando così il corpo della lampada e il suo effetto luminoso.

Floor lamp with convertible Tyvek® diffuser. Through the free manipulation, it is possible to model and vary the dimensions in height: thus personalizing the body of the lamp and its luminous effect.





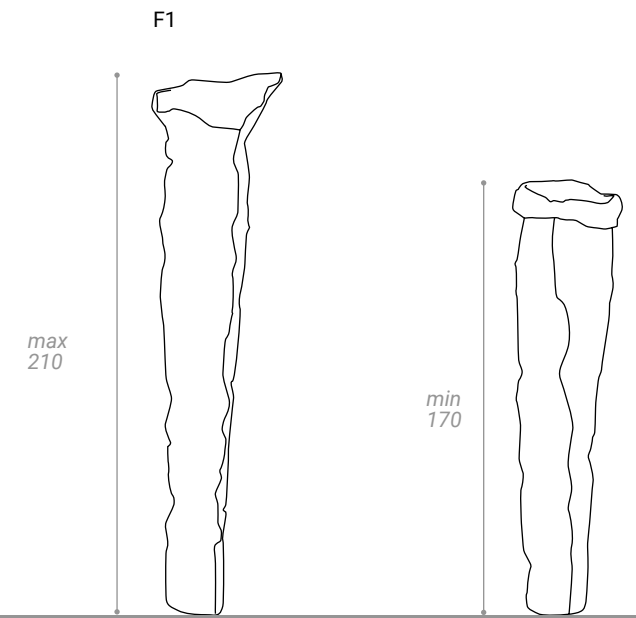

TYVEK®: CARATTERISTICHE TECNICHE DEL MATERIALE

- Riciclabilità 100%
- Resistenza alla rottura/strappi
- Stabilità e Inalterabilità nel tempo
- Resistenza all'acqua/lavabile
- Resistenza alle alte e basse temperature
- Atossicità
- Resistenza agli agenti chimici
- Resistenza raggi UV

TYVEK®: TECHNICAL CHARACTERISTICS OF THE MATERIAL

- Recyclability 100%
- Breaking strenght
- Stability and durability over time
- Water resistant – washable
- Resistance to high and low temperatures
- Non-toxic
- Resistance to chemicals
- UV resistance

MATERIALI/MATERIAL:  
Tyvek®/Tyvek®

FINITURE/  
FINISHES

F1 Par38 E27 16W 10° ◀ Dimmer included



BIANCO/  
WHITE





# TORCETTA

design R&S Antonangeli 2010



Piccola sospensione a LED utilizzabile singolarmente o in aggregato, per installazioni luminose personalizzate.

Small LED suspension that can be used individually or in aggregate, for a customized light installation.

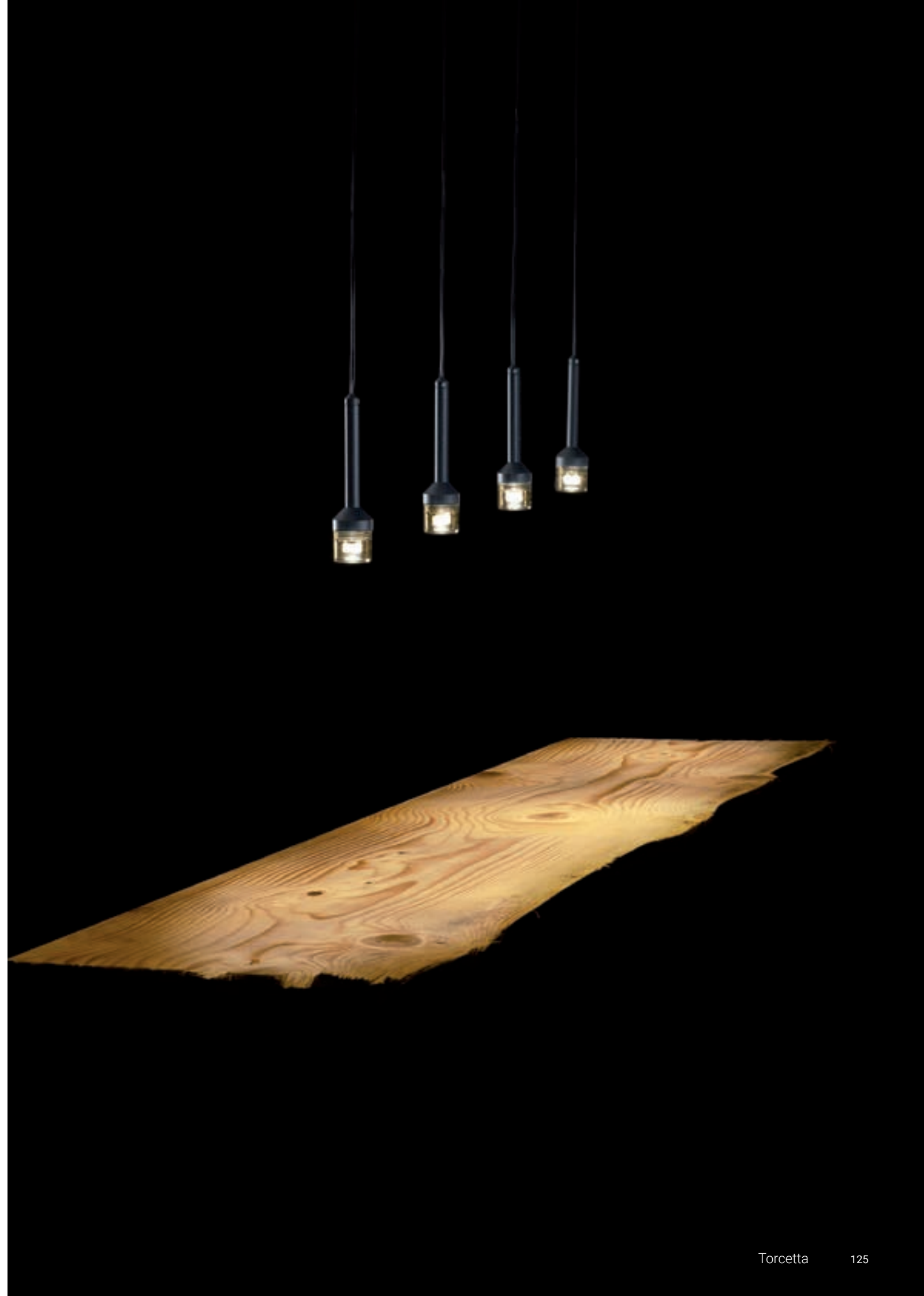







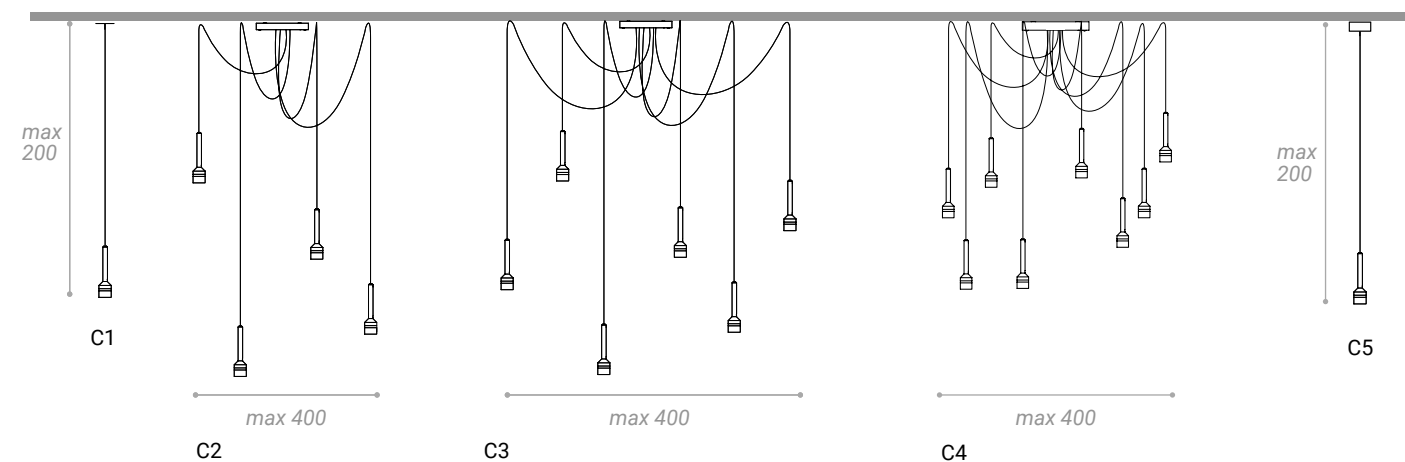

- C1 Led 3W 700mA 160Lm 3000°k Remote driver
- C2 4x Led 3W 700mA 640Lm 3000°k Driver included
- C3 6x Led 3W 700mA 960Lm 3000°k Driver included
- C4 8x Led 3W 700mA 1280Lm 3000°k Driver included
- C5 Led 3W 700mA 160Lm 3000°k Driver included

C1 a richiesta/on demand  
 C2/C3/C4/C5 a richiesta/on demand

MATERIALI/MATERIALS  
metallo/metal

FINITURE/  
FINISHES

BIANCO/  
WHITE

BRONZO/  
BRONZE

NERO/  
BLACK





# ROBINHOOD

design Gianfranco Marabese 2019



Lampada essenziale e leggera: una struttura in metallo sostiene l'elemento luminoso in silicone, che diffonde una luce morbida ma piena, a 360°. Il basamento ospita al suo interno un ricevitore di impulsi radio e con un telecomando è possibile dosare la luce a piacere.

Essential and light lamp: a metal structure supports the silicone luminous element, which diffuses a soft but full light, at 360°. The base houses inside a radio pulse receiver and with remote control it is possible to dose the light at will.



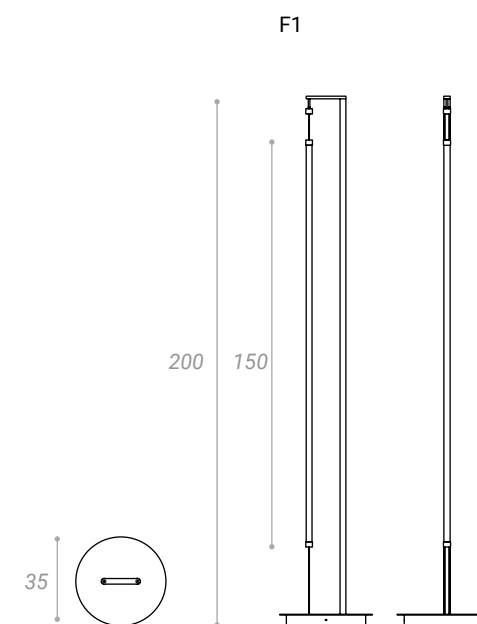

MATERIALI/MATERIALS  
 metallo/metal  
 silicone/silicone

FINITURE/  
 FINISHES

BIANCO/  
 WHITE

BRONZE/  
 BRONZE

OTTONE/  
 BRASS

RAME/  
 COPPER



F1 Double strip Led 24V 36W 3360Lm 2700°K /3000°K/4000°K Dimmer included





# GARDEN COLLECTION

design Gianfranco Marabese 2023



Garden nasce nel 1996 come piccolo diffusore di luce orientabile in alluminio, agganciato ad un supporto flessibile. Il nuovo disegno del diffusore e la nuova tecnica strutturale hanno permesso di introdurre due nuovi diffusori ad alte prestazioni luminose ed effetti scenici. Attraverso la flessibilità dei supporti, infatti, molteplici sono i posizionamenti possibili che personalizzano la direzionalità della luce.

Garden was created in 1996 as a small, adjustable aluminium light diffuser attached to a flexible support. The new diffuser design and the new structural technique allow to introduce two new diffusers with high lighting performance and scenic effects. Through the flexibility of the supports, in fact, there are multiple possible positions that customize the directionality of the light.











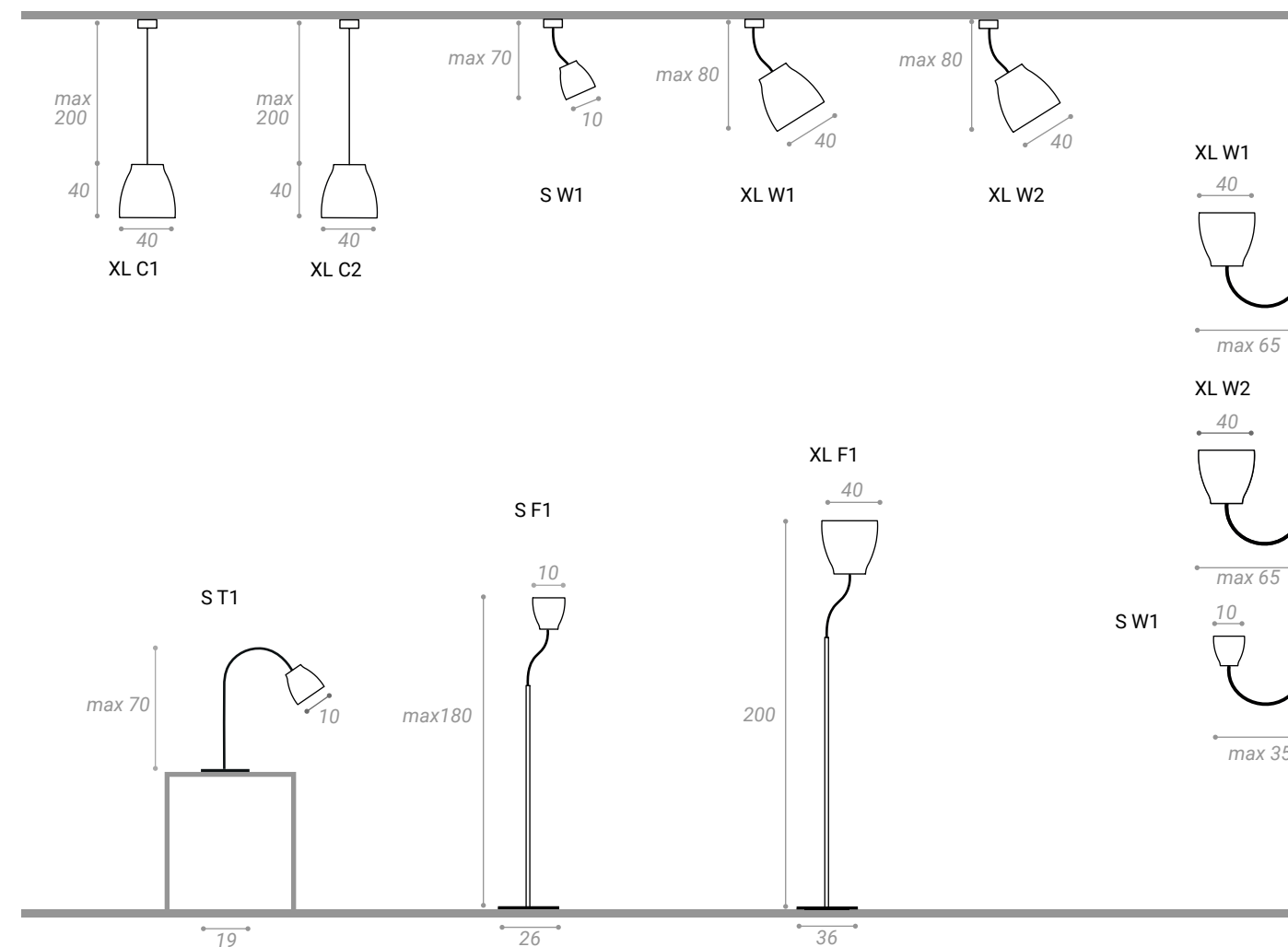

MATERIALI/MATERIALS  
alluminio/aluminium

FINITURE/  
FINISHES



XL F1	3x E27 20W 2500Lm tot. 7500W		
XL C2			
XL W2			
XL C1	E27 20W 2500Lm		
XL W1			
S W1	E27 20W 2500Lm		
S F1			
S T1			

- XL F1 Dimmer touch
- S F1/S T1 Dimmer included
- XL W2 Dimmer touch
- XL W1/XL C1/XLC2/S W1 Dimmer touch



# VIOLINO

design Gabi Peretto 2017



Sospensione generata da un tubo metallico che si avvolge su sé stesso ed é supporto e struttura per una lampadina a vista o un cilindro con cui ottenere coni di luce variabili.

Suspension generated by a metal tube that wraps around itself and it is support and structure for a visible light bulb or a cylinder with which to obtain variable light cones.



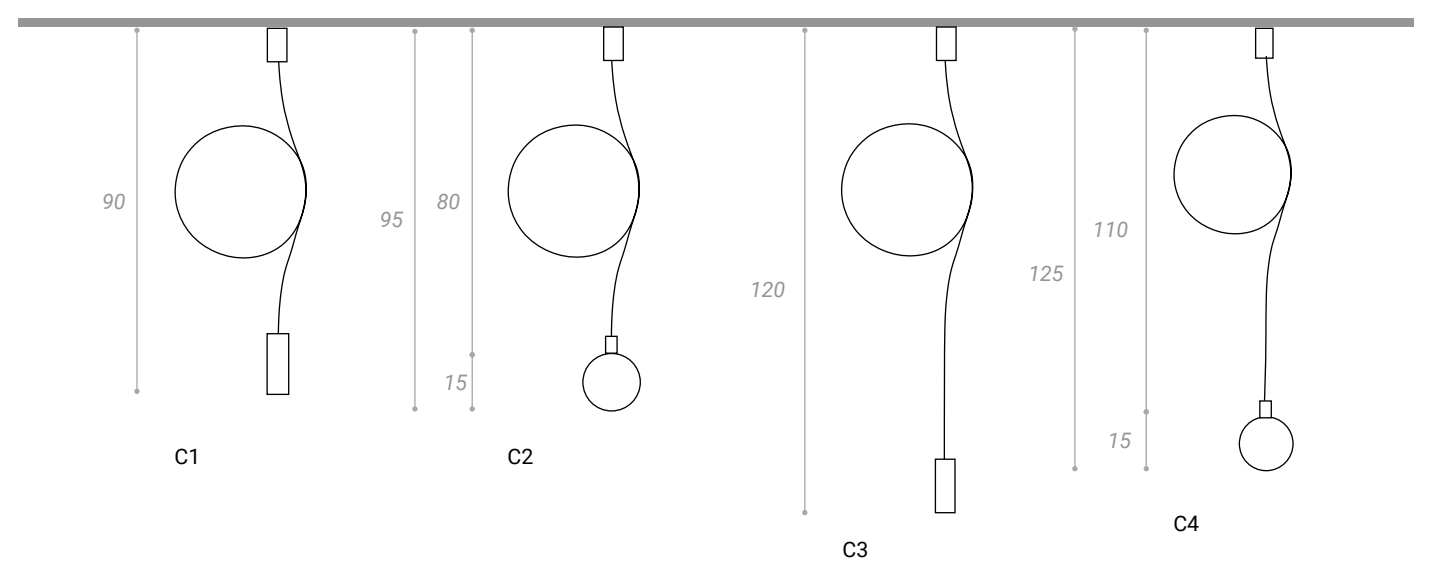

- C1 } GU10 110/230V
- C3 } GU10 110/230V
- C2 } Globolux E27 110/230V
- C4 } Globolux E27 110/230V



MATERIALI/MATERIALS  
metallo/metal

FINITURE/  
FINISHES

- BIANCO/  
WHITE
- NERO/  
BLACK
- OTTONE/  
BRASS



# LE GINE

design Sebastiano Tosi 2017



Serie di sospensioni in metallo, di forma diversa, che possono dialogare ed integrarsi tra loro, componendo liberamente, grappoli di luce personalizzati.

Series of metal suspensions, of different shapes, which can dialogue and integrate each other, composing freely, customized cluster of light.







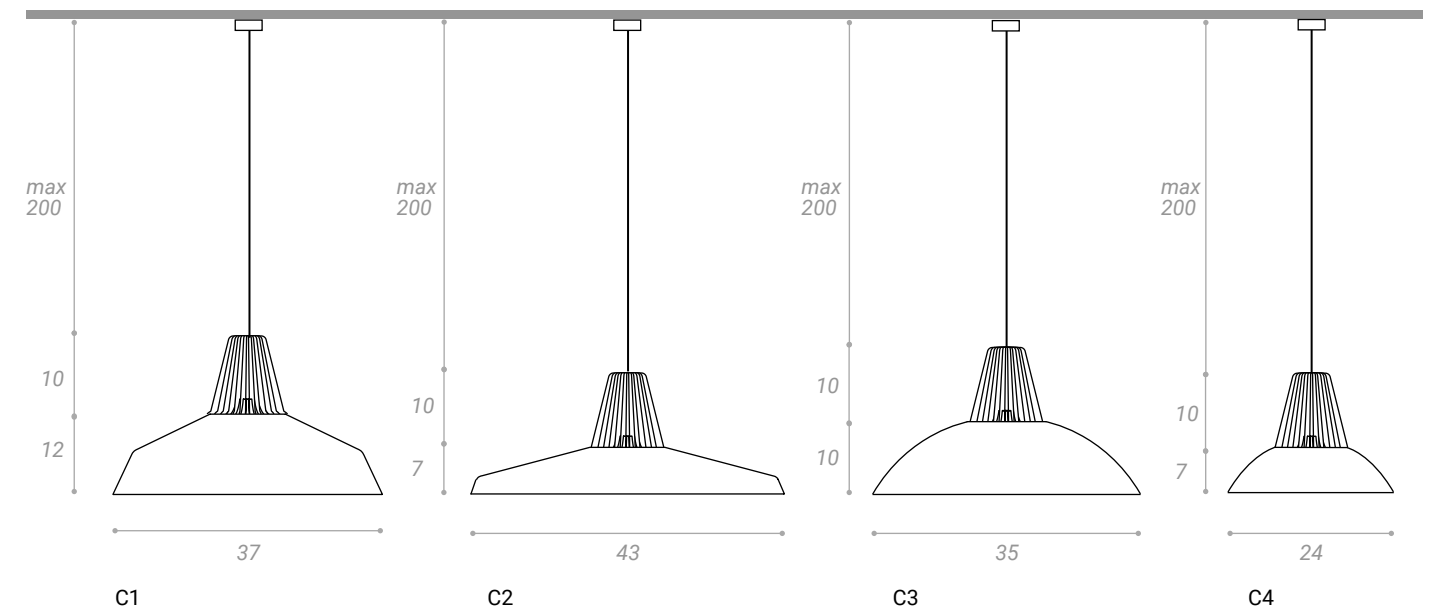
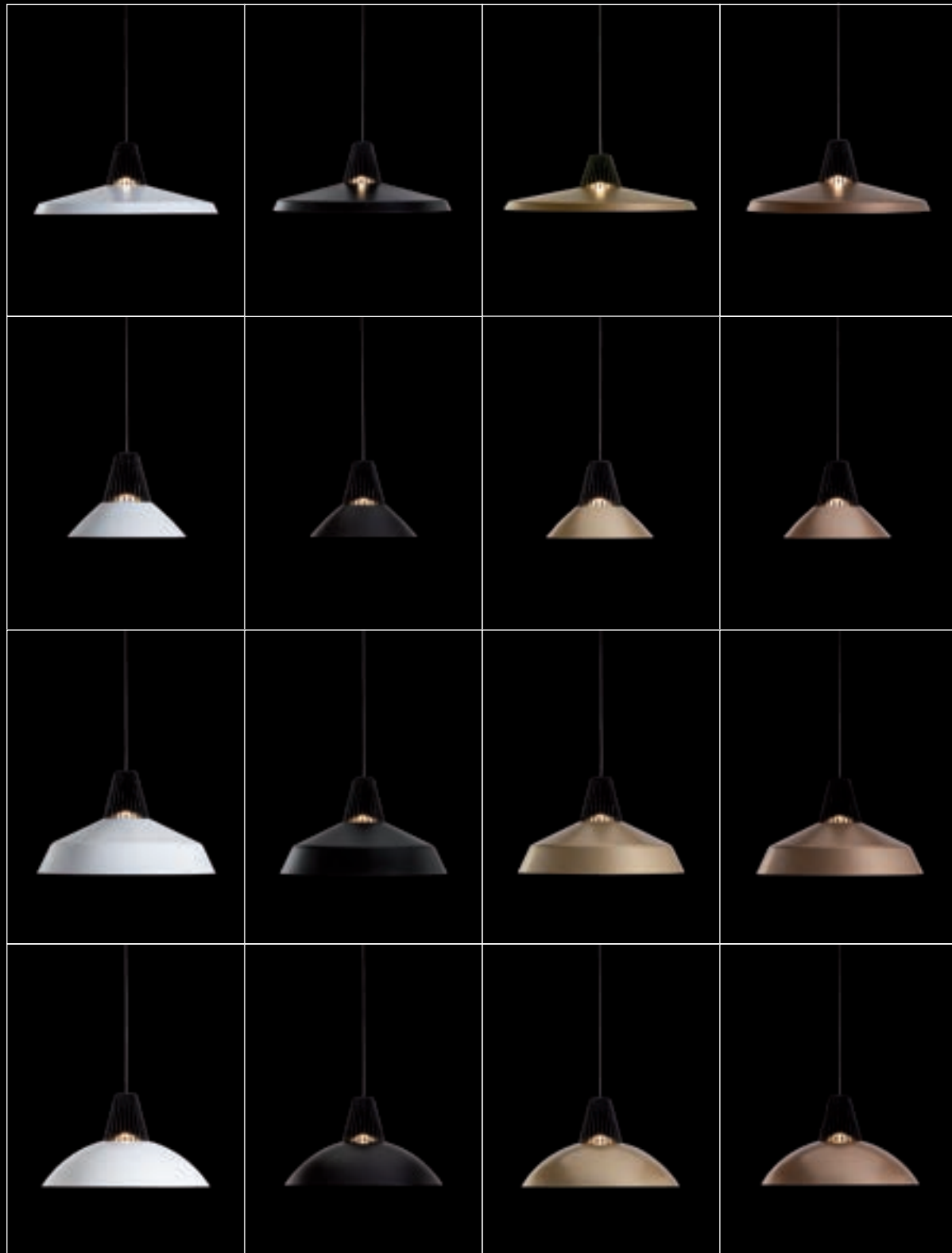

C1  
C2  
C3  
C4

GU10 110/230V



MATERIALI/MATERIALS  
metallo/metal

FINITURE/  
FINISHES

BIANCO/  
WHITE

BRONZE/  
BRONZE

NERO/  
BLACK

OTTONE/  
BRASS



# RICAMI

design Gianfranco Marabese 2009



Collezione di lampade a paralume, con diffusore in fibra di vetro bianco caldo, di diverse dimensioni e soluzioni tipologiche: resistente all'urto, lavabile, di facile manutenzione. Un cilindro di vetro borosilicato, all'interno del paralume, avvolge e scherma le fonti luminose per evitare abbagliamenti.

Collection of lampshades with diffuser in warm white fiberglass, of different sizes and typological solutions: impact resistant, washable, easy to maintain. A cylinder of borosilicate glass, inside the lampshade, wraps and shields light sources to avoid glare.







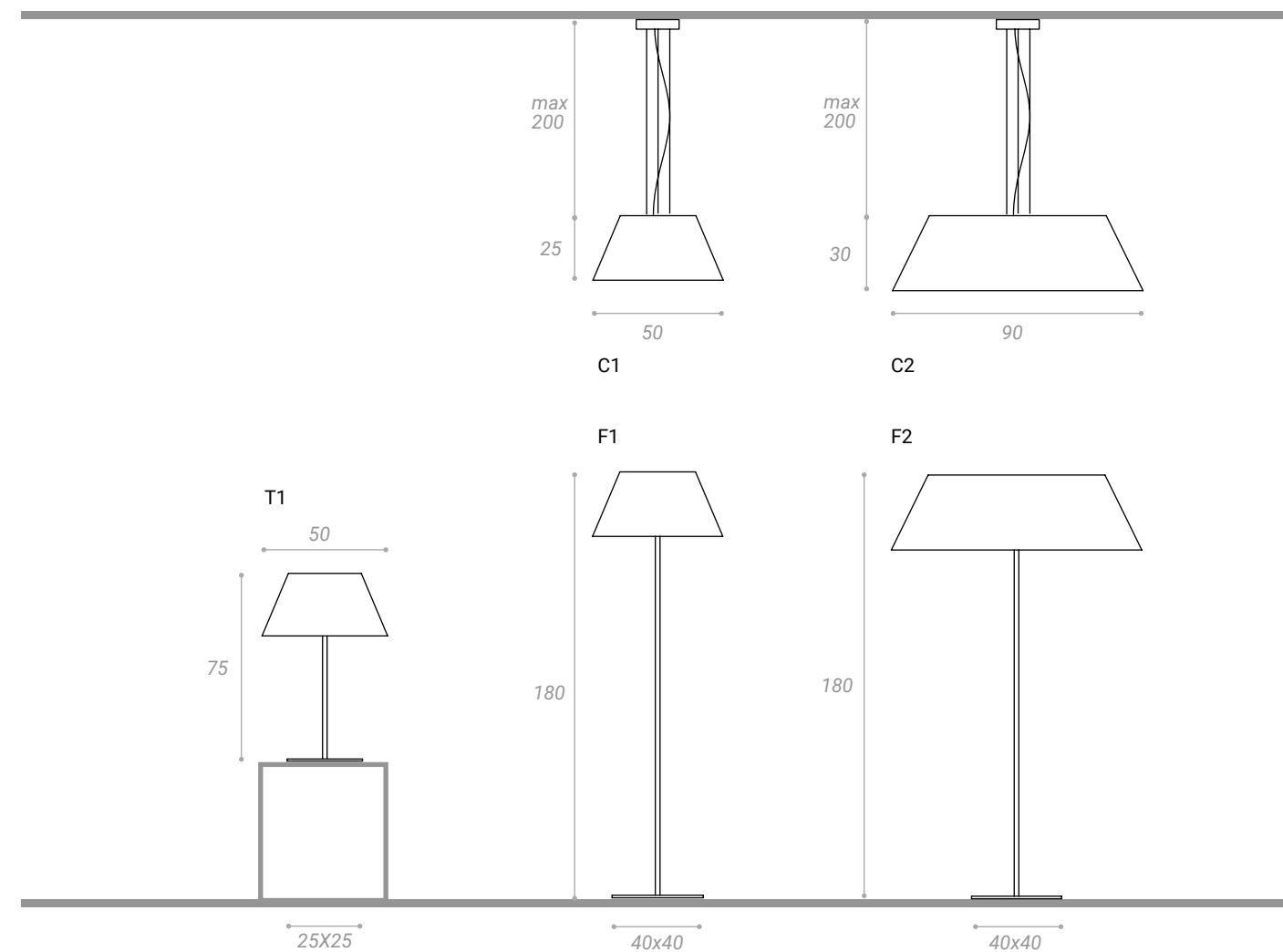

C1  
C2  
F1  
F2  
T1

E27 20W 2500Lm

C1/C2 Dimmer included  
 F1/F2/T1

MATERIALE/MATERIAL  
metallo/metal

FIBRA DI VETRO/  
FIBERGLASS

FINITURE/  
FINISHES

BIANCO CALDO/  
WARM WHITE

BRONZO/  
BRONZE





# MIAMI

design Giordana Arcesilai 2007



Un diffusore in fibra di vetro bianco caldo, che rappresenta l'icona classica del paralume, diffonde una luce morbida, accogliente e rassicurante. E' resistente all'urto, lavabile, di facile manutenzione, utilizzabile ovunque. Un cilindro di vetro borosilicato, all'interno del paralume, avvolge e scherma le fonti luminose per evitare abbagliamenti.

A warm white fiberglass diffuser, which is the classic icon of the lampshade, diffuses a soft, welcoming and reassuring light. It is impact-resistant, washable, easy to maintain and can be used anywhere. A cylinder of borosilicate glass, inside the lampshade, wraps and screens light sources to avoid dazzling.





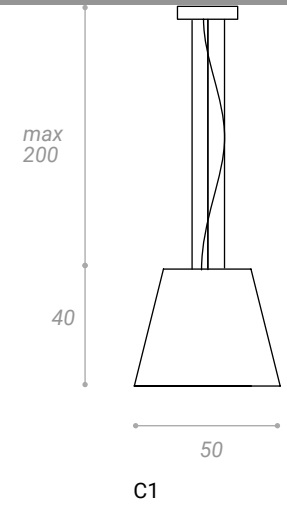

MATERIALI/  
MATERIAL

FIBRA DI VETRO/  
FIBERGLASS



FINITURE/  
FINISHES

BIANCO CALDO  
WARM WHITE



C1 E27 20W 2500Lm





# NOVECENTO

design Claudio Bitetti 2009

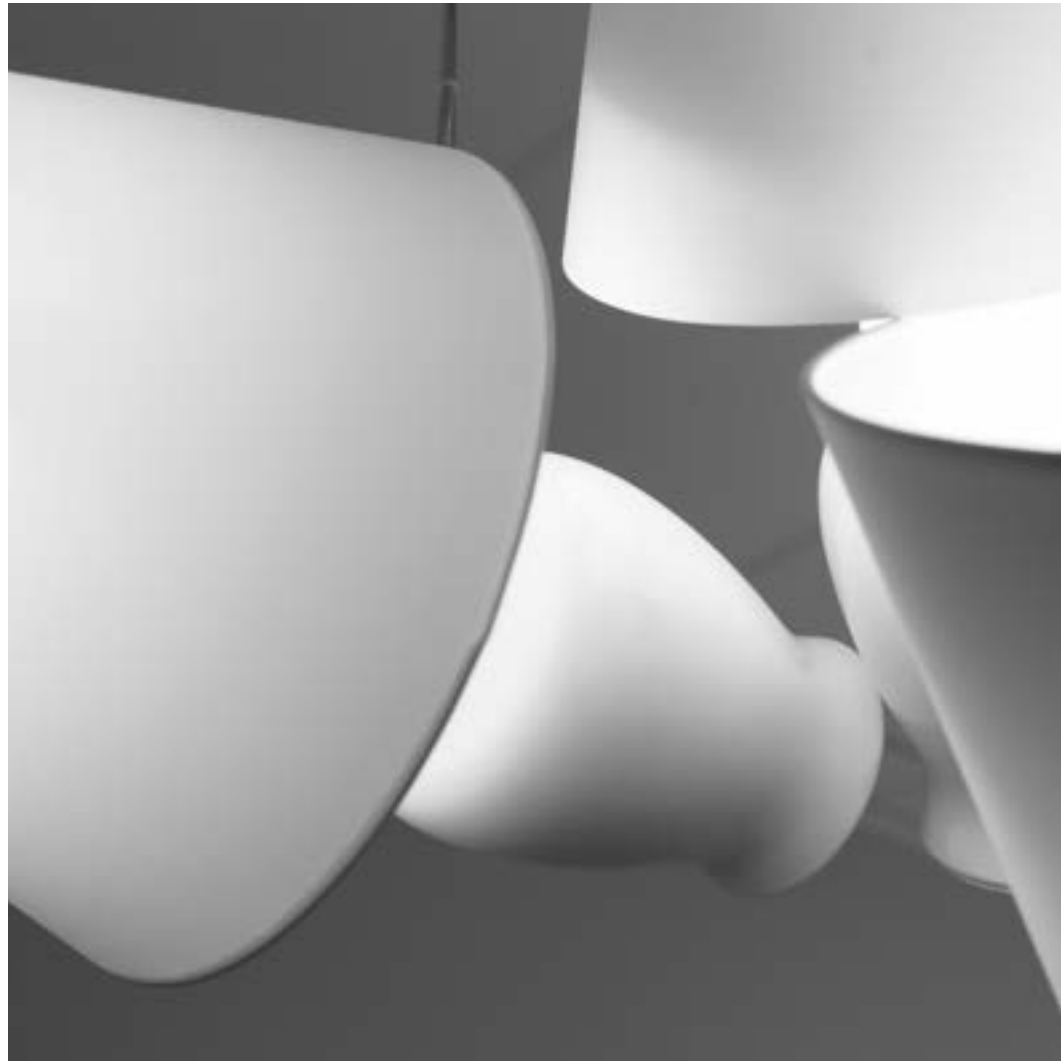

Da una ispirazione, che raccoglie una tradizione e la trasforma con ironia, nascono sospensioni uniche. L'aba-jour di memoria si confronta con il ready-made: l'oggetto e la sua trasformazione, per realizzazioni originali, personalizzate.

From an inspiration, which gathers a tradition and transforms it with irony, unique suspensions are born. The memory aba-jour confronts the ready-made: the object and its transformation, for original, personalized creations.





min 80  
max 220

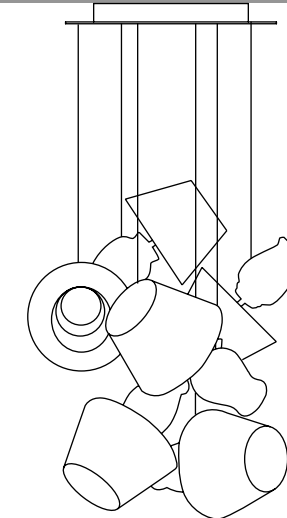

max 120

C2

C2 6x E27 13W 1500Lm 9000Lm 



MATERIALI/ MATERIAL  
ceramica/ceramic  
tessuto/fabric

FINITURE/  
FINISHES

BIANCO E ORO/  
WHITE AND GOLD





# FORMOSA

design Aldo Cibic 2005



Collezione articolata di lampade con paralume in tessuto di forma asimmetrica, disponibile nelle versioni singole o in aggregato, per ottenere morbide sculture di luce, di grande atmosfera.

An articulated collection of lamps with an asymmetrically shaped fabric shade, available in single or grouped versions to obtain soft light sculptures with a great atmosphere.











170 Formosa/ Private home, Vicenza, Italy



Formosa/ Laboratorio del Colore, Lissone, Italy 171



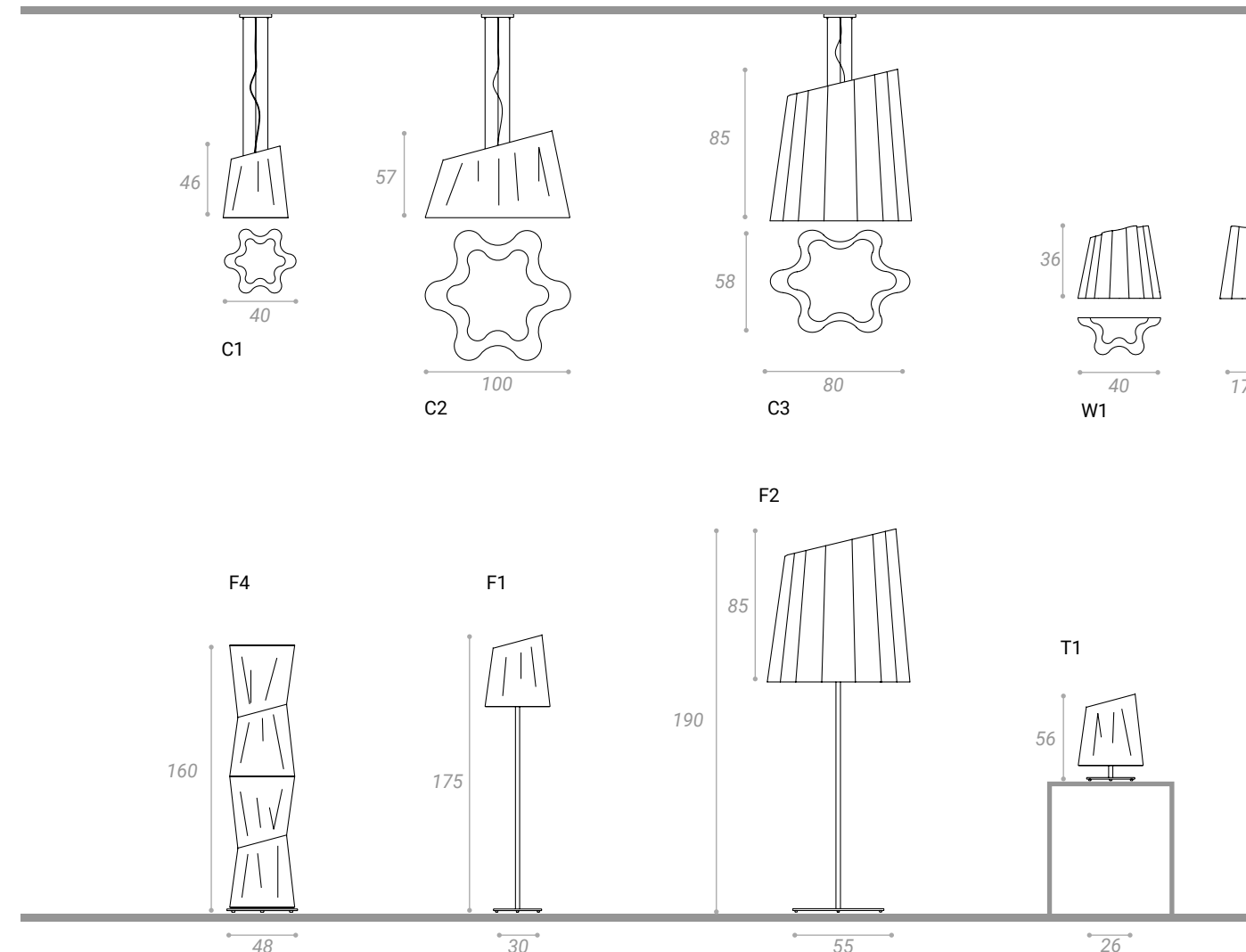

- W1
- C1 } E27 20W 2500Lm
- C2 }
- C3 }
- T1 } 2x E14 5W 800Lm (1600Lm) Dimmer included
- F1 } Dimmer included
- F2 } 3x E27 20W 2500Lm (7500Lm) Dimmer included
- F4 } 8x E14 5W 800Lm (6400Lm) Dimmer included

C1/C2/C3  
 F1/F2/F4/T1/W1

MATERIALI/ MATERIAL  
 tessuto/fabric

FINITURE/  
 FINISHES

BIANCO/  
 WHITE

ROSSO/  
 RED





# SOUL

design Romeo Guaricci 2019

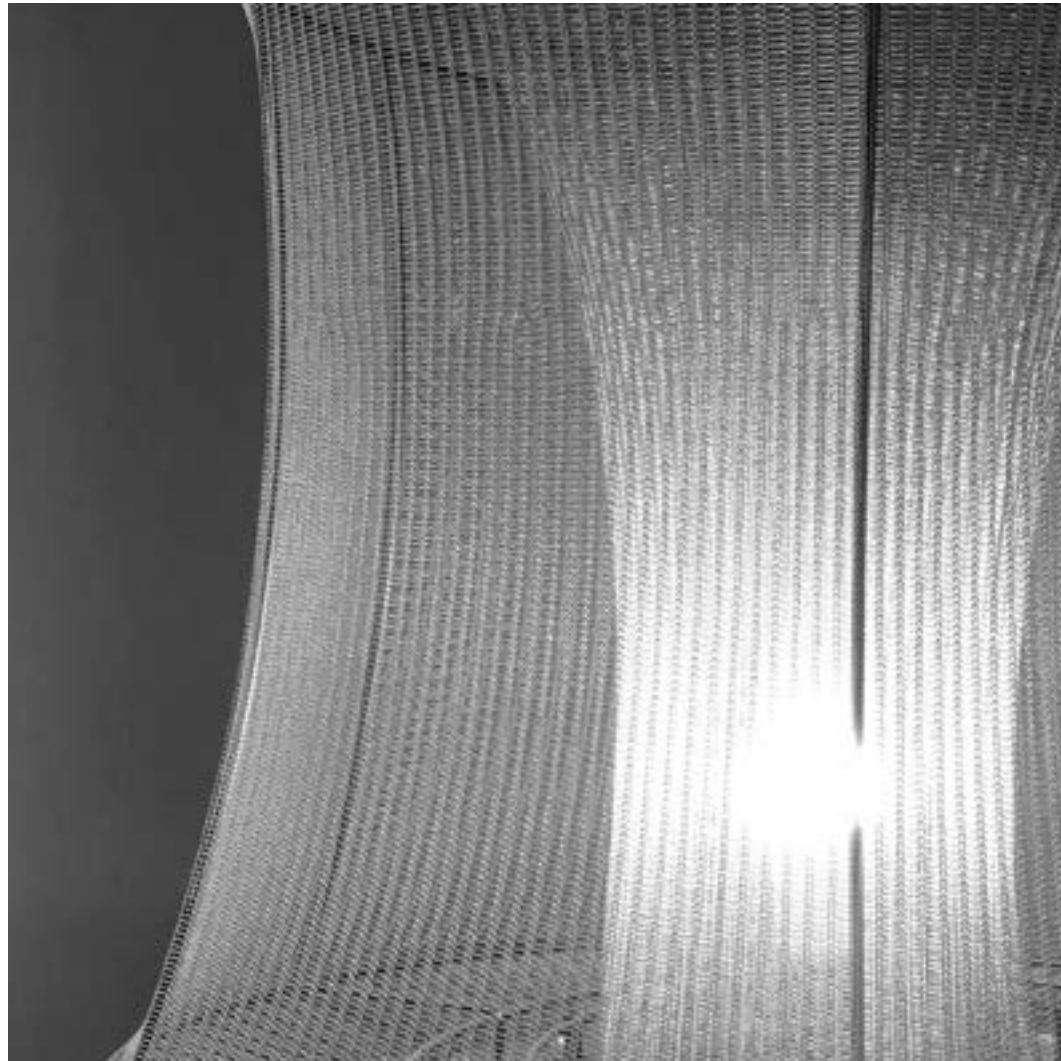

Collezione che traduce forme iconiche in un oggetto dal segno innovativo, esclusivo, in grado di personalizzare ogni tipo di ambiente. La luce che diffonde, nasce dal contrasto tra volume e trasparenza, nell'accordo tra l'originale rivestimento a 'tricot' e lo struttura in metallo che la sostiene.

Collection that translate iconic shapes into an object with an innovative, exclusive sign, able to personalize any type of environment. The light that it diffuses comes from the contrast between volume and transparency, in the agreement between the original "tricot" coating and the metal structure that supports it.





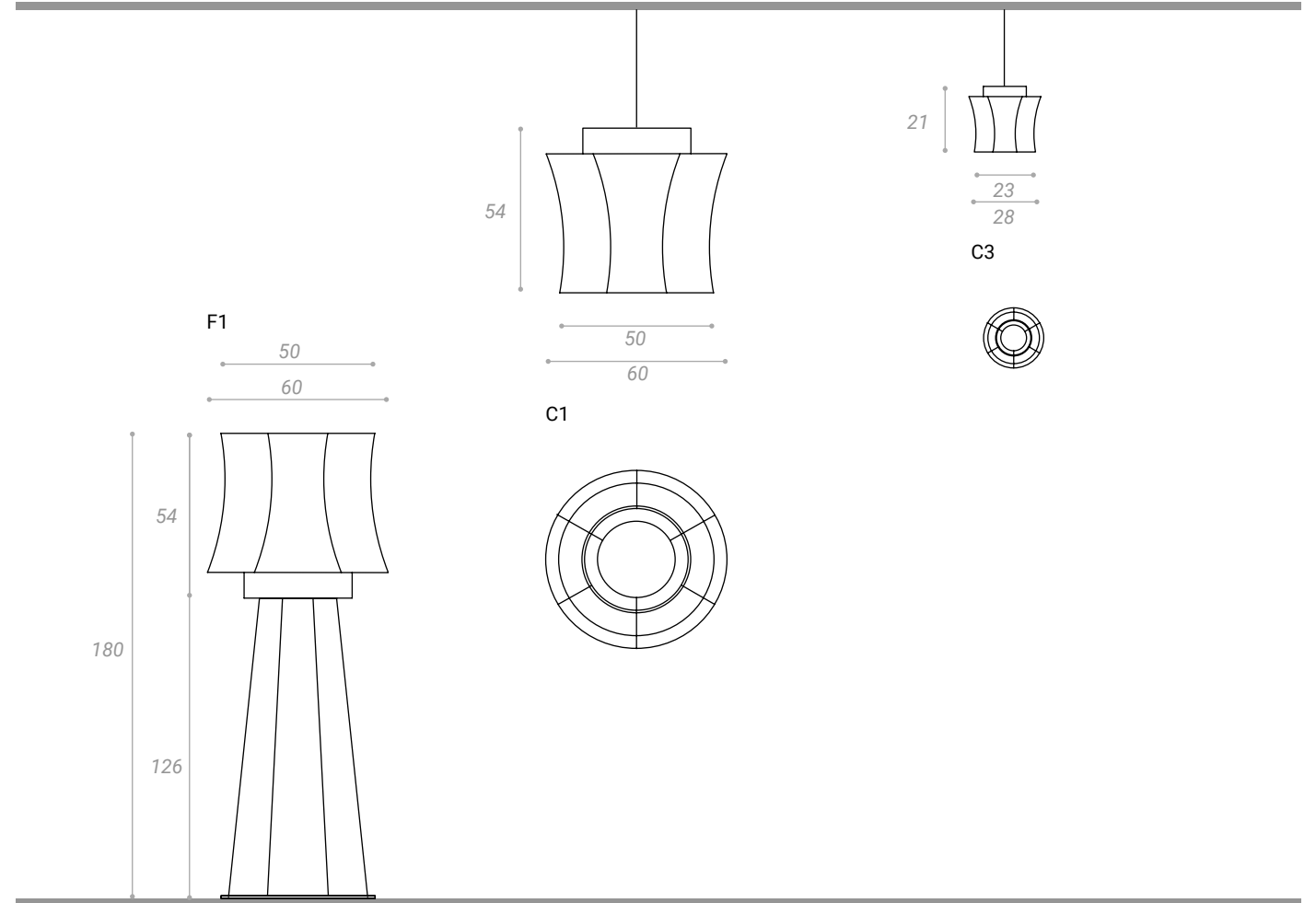

F1 E27 2550Lm Dimmer included  
 C1 E27 2550Lm   
 C3 G9

C1/C3  
 F1

MATERIALI/MATERIAL  
 filo vinile/vinyl thread  
 metallo/metal

FINITURE/  
 FINISHES

BIANCO/  
 WHITE

BRONZO/  
 BRONZE

ROSSO/  
 RED

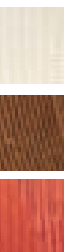



# FLAMBEAU

design Giordana Arcesilai 2017



Lampada da appoggio o da sospendere, ricaricabile, per un funzionamento autonomo, senza fili. La raffinata lavorazione in rame, ottone o acciaio, fa filtrare la luce in modo suggestivo, creando effetti luminosi fortemente emozionali.

Standing or hanging lamp, rechargeable, for an autonomous wireless functioning. The refined workmanship in copper, brass or steel, filters the light in a suggestive way, creating highly emotional lighting effects.







RICARICABILE. 12 Ore di luce senza fili  
RECHARGEABLE. 12 Hours of wireless light



T1 Led 4W 400Lm 3000°K

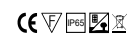

MATERIALE/ MATERIAL  
metallo/metal

FINITURE/  
FINISHES

ACCIAIO/  
STEEL



OTTONE/  
BRASS



RAME/  
COPPER





# CU-BOX

design Gianfranco Marabese 2016



Cu-box è un proiettore a luce diretta, di dimensioni contenute, utilizzabile a parete e a soffitto per illuminare con discrezione e precisione, senza abbagliare.

Cu-box is a small direct light projector that can be used on wall and ceiling to discreetly and precisely illuminate without glare.



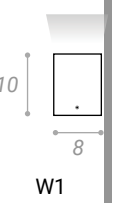
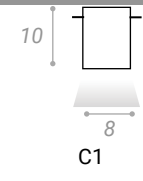

MATERIALE/MATERIAL  
alluminio/aluminium



FINITURE/  
FINISHES

WHITE/  
BIANCO

BRONZO/  
BRONZE

NERO/  
BLACK



C1  
W1 ] GU10 110/220V  





# MAKE UP

design Gianfranco Marabese 2016



Lampada da parete orientabile, disponibile in due larghezze e due profondità, dal disegno pulito e armonico: ideale per illuminare con una luce puntuale e dedicata, specchi e quadri.

Adjustable wall lamp, available in two widths and two depths, with a clean, harmonious design: ideal for illuminating mirrors and pictures with a focused and dedicated light.



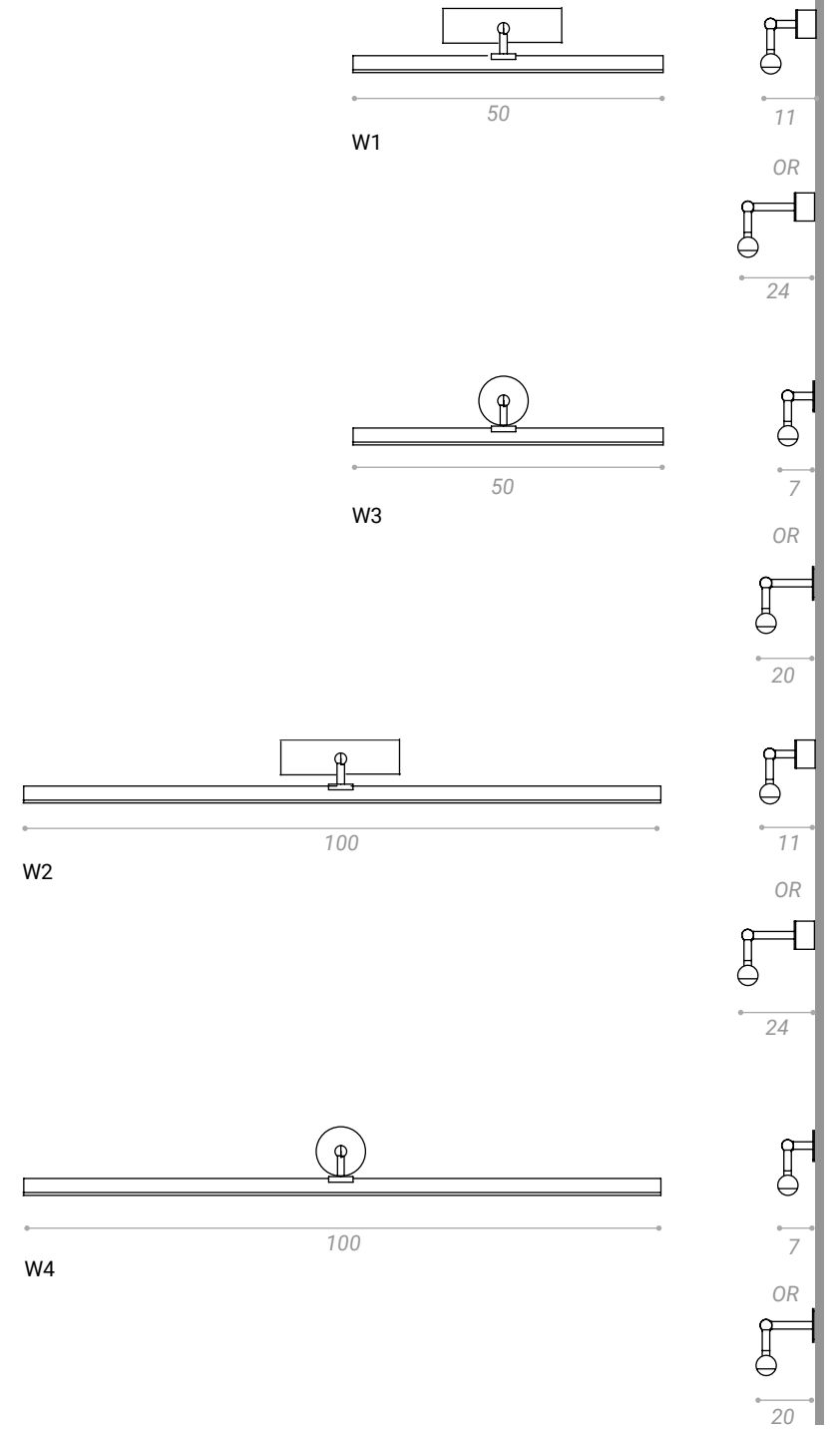

W1 } Led 15W/24V 1400Lm 3000°k  
 W3 }  
 W2 } Led 30W/24V 2800Lm 3000°k  
 W4 }

☑ ☑ ☑ ☑ ☑ W1/W2 Driver included  
 ☑ ☑ ☑ ☑ ☑ W3/W4 Remote driver

MATERIALE/MATERIAL  
 alluminio/aluminium

FINITURE/  
 FINISHES

CROMO/  
 CHROME







# OUTDOOR



*"Le Collezioni Outdoor nascono con le stesse modalità delle Collezioni Indoor, alle quali spesso assomigliano, perché ho sempre pensato di vedere realizzata per l'imbrunire come per la notte, una luce tecnica ma di atmosfera: rispettando la natura e promettendo alle persone di godere tutta la bellezza in una corrispondenza il più possibile completa e personale."*

*"The Outdoor Collections are created in the same way as the Indoor Collections, to which they often resemble, as I have always thought of seeing a technical but also a mood light realized for dusk as for night: respecting nature and promising people to enjoy all its beauty in a correspondence as complete and personal as possible."*

Gianfranco Marabese 2024



# BANANO

design AG&P greenscape + Cattaneo design, 2024



Banano è la prima proposta di una serie articolata di collezioni, 'Nature Light System', ispirate dalla natura: una vera e propria scultura luminosa realizzata con materiali interamente riciclabili, acciaio e fibra di vetro. Curve fluide, linee delicate ricreano la grazia naturale della foglia e trasmettono un senso di armonia organica e di bellezza senza tempo.

Banano is the first proposal of an articulated series of collections, 'Nature Light System', inspired by nature: a true lighting sculpture made by recyclable materials, steel and fibreglass. Flowing curves, delicate lines recreate the natural grace of the leaf and convey a sense of organic harmony and timeless beauty.

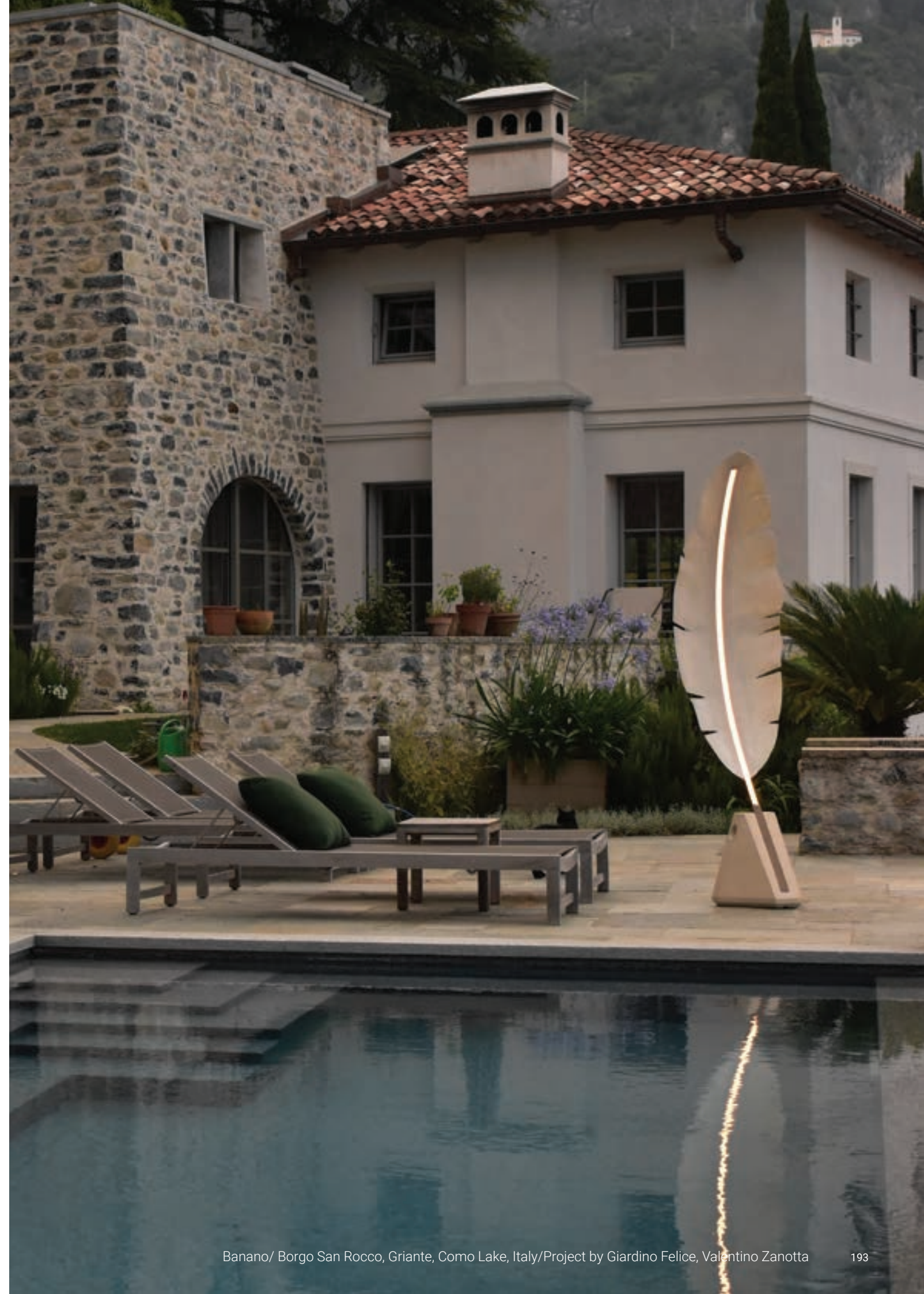











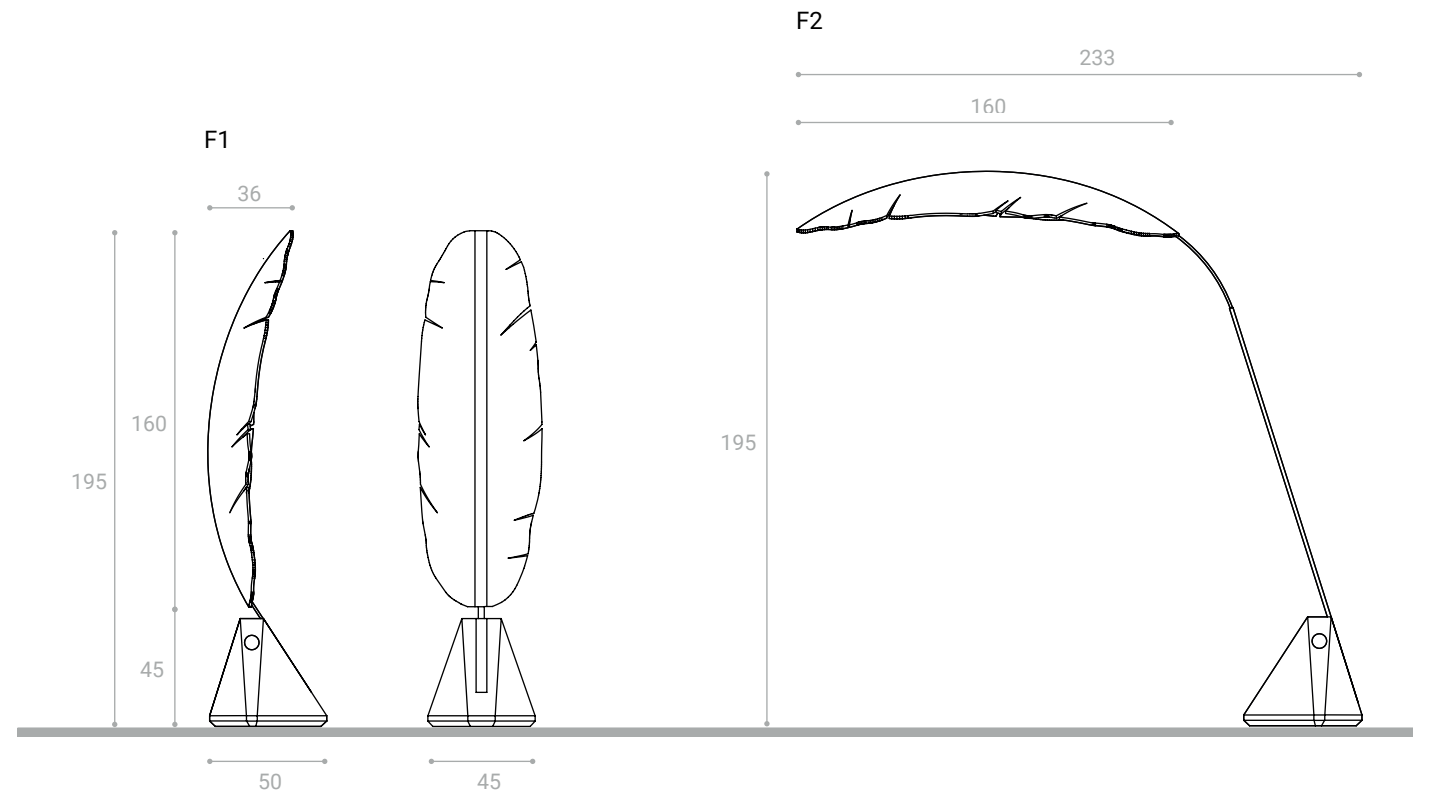

F1 LED 2700K 22W 24V  
 F2 LED 2700K 25W 24V

Ⓢ Ⓜ Ⓝ Dimmer with remote control included



MATERIALI/ MATERIALS  
 fibra di vetro/fiberglass  
 acciaio inox/stainless steel  
 cemento/concrete

FINITURE/  
 FINISHES





# SOFFIO

design Gianfranco Marabese 2021



Un diffusore sferico ospita la fonte luminosa e una lente in silicone che diffonde la luce senza abbagliare. Il supporto in rame naturale, sul quale si forma nel tempo una patina che aumenta la durata, si confonde nella natura, contribuendo ad integrarne Soffio: un fiore luminoso discreto, protagonista nell'oscurità.

A spherical diffuser houses the light source and a silicone lens that diffuses the light without glare. The natural copper support, on which forms a patina over time which increases its durability, blends into the nature, helping to integrate Soffio: a discreet luminous flower, protagonist in the darkness.









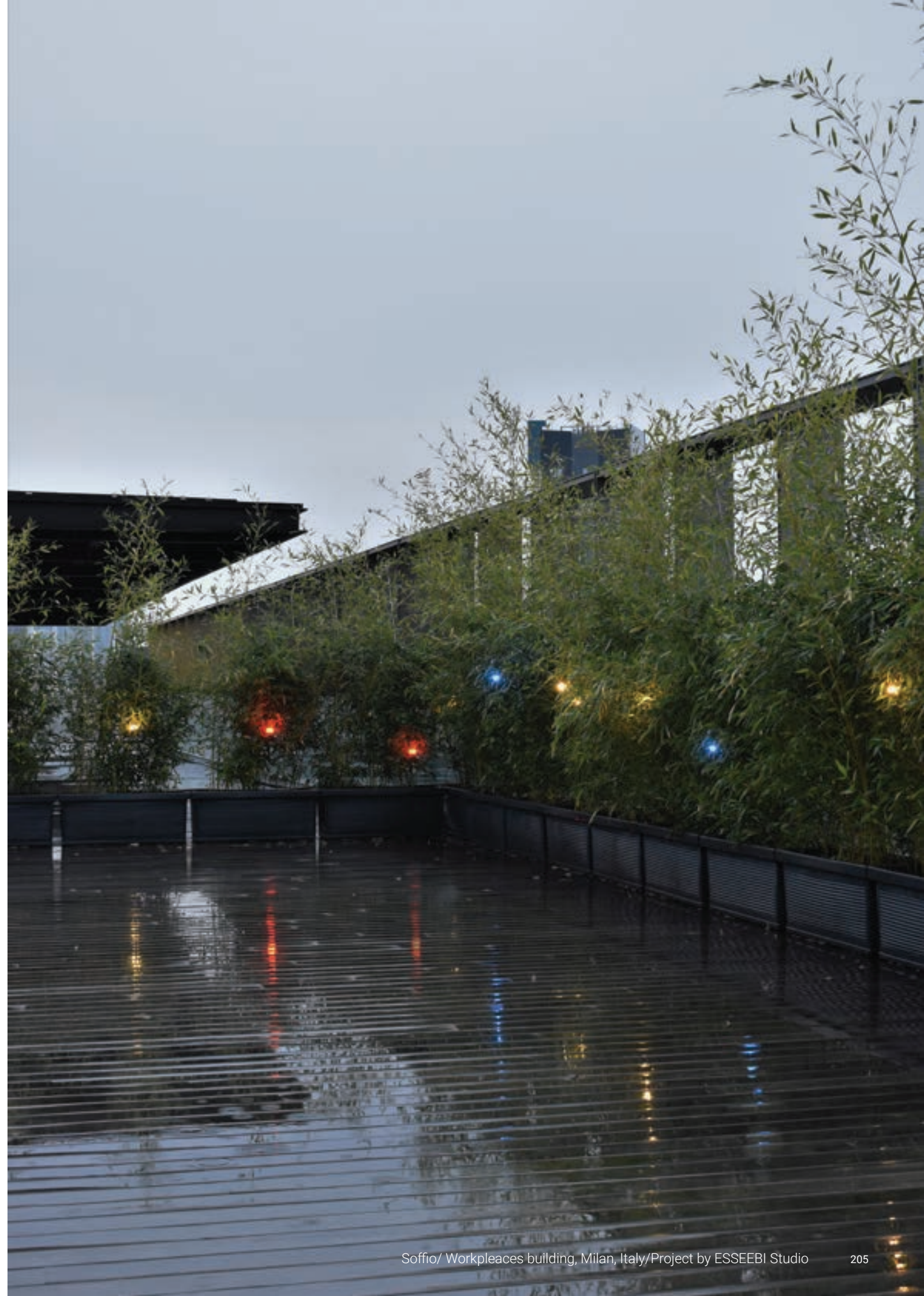



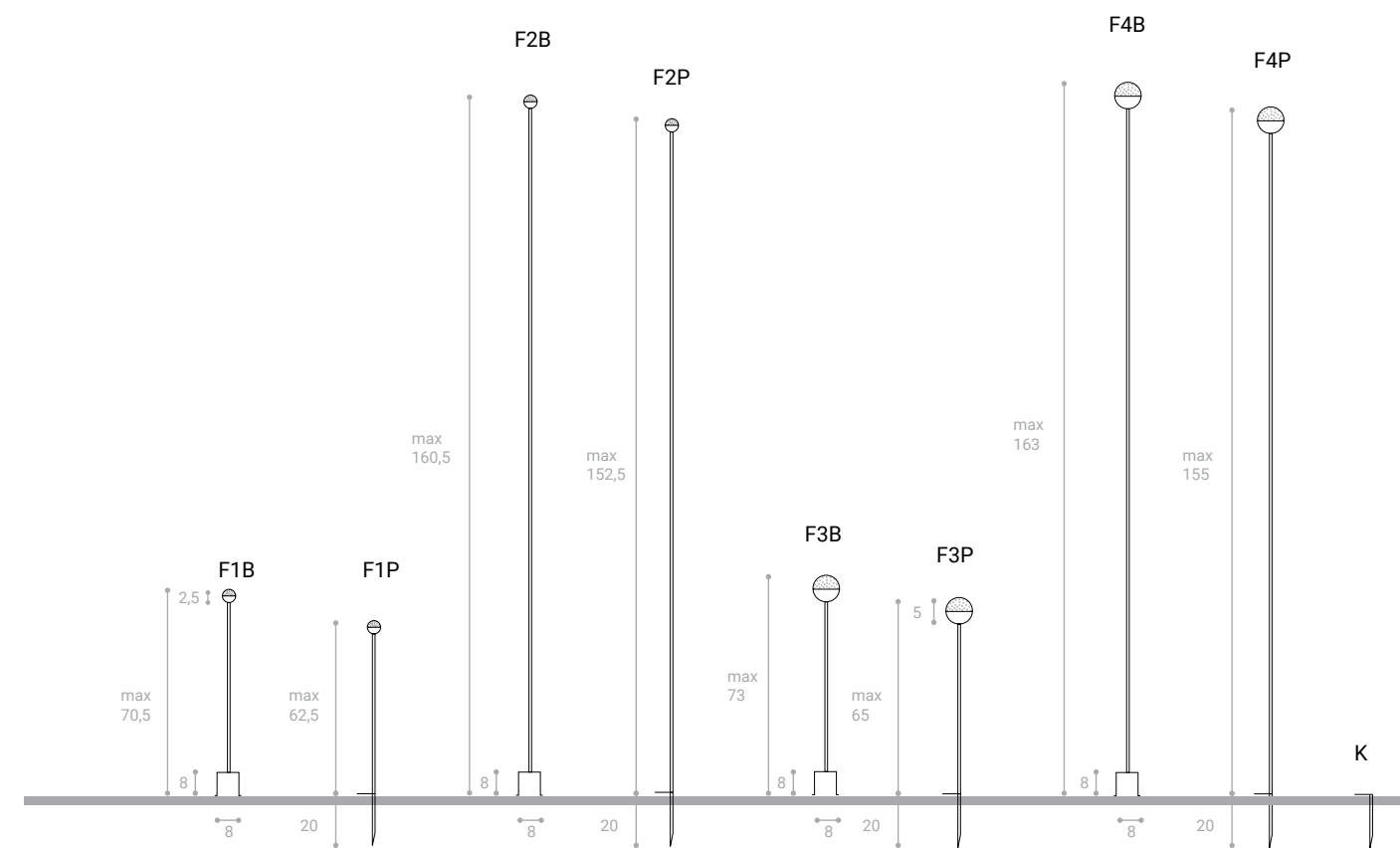
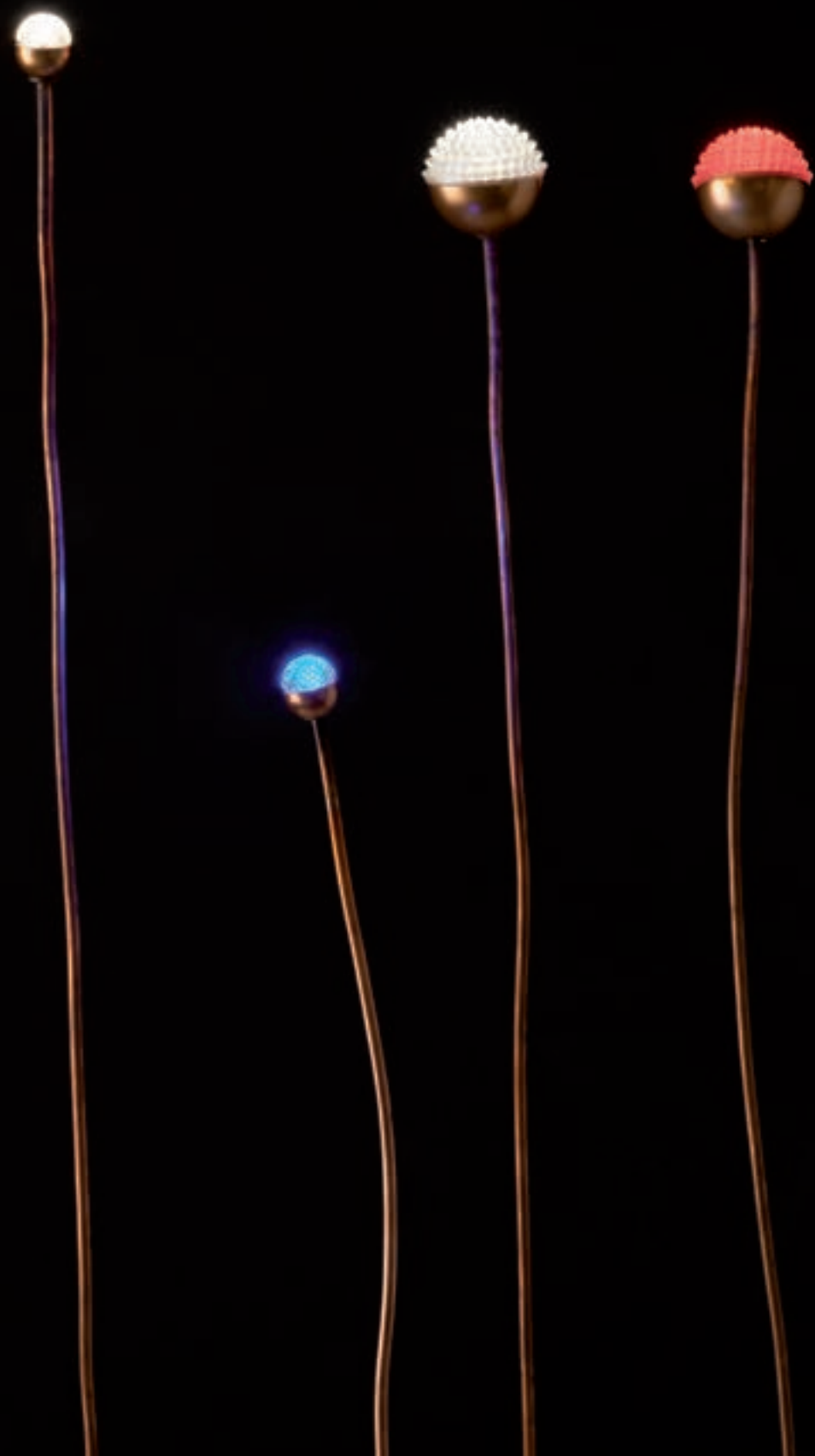

- F1B ]
- F2B ] Led 1W 220Lm 350mA    Driver included    Picket optional
- F3B ]
- F4B ]
- F1P ]
- F2P ] Led 1W 220Lm 350mA    Remote driver
- F3P ]
- F4P ]

LED: 3000°K-2700°K  
 BIANCO/WHITE  
 BLU-BLUE/  
 ROSSO-RED

MATERIALE/MATERIAL  
 rame/copper

FINITURE/  
 FINISHES

RAMA/  
 COPPER



# MIAMI

design Giordana Arcesiali 2007



Collezione che nasce per portare all'esterno l'atmosfera della luce degli interni. Un paralume in fibra di vetro bianco caldo, diffonde una luce morbida, accogliente. Il disegno essenziale della struttura, esalta la semplicità del diffusore, pensato e prodotto per essere resistente alle intemperie e agli sbalzi termici.

Collection that was created to bring the atmosphere of interior light to the outside. A warm white fiberglass shade diffuses a soft, welcoming light. The essential design of the structure, enhances the simplicity of the diffuser, designed and produced to be resistant to weather and sudden temperature fluctuations.















214 Miami/ Borgo San Rocco, Griante, Como lake, Italy/Project by Giardino Felice, Valentino Zanotta



Miami/ L'Olmo, Val D'orcio, Tuscany, Italy 215



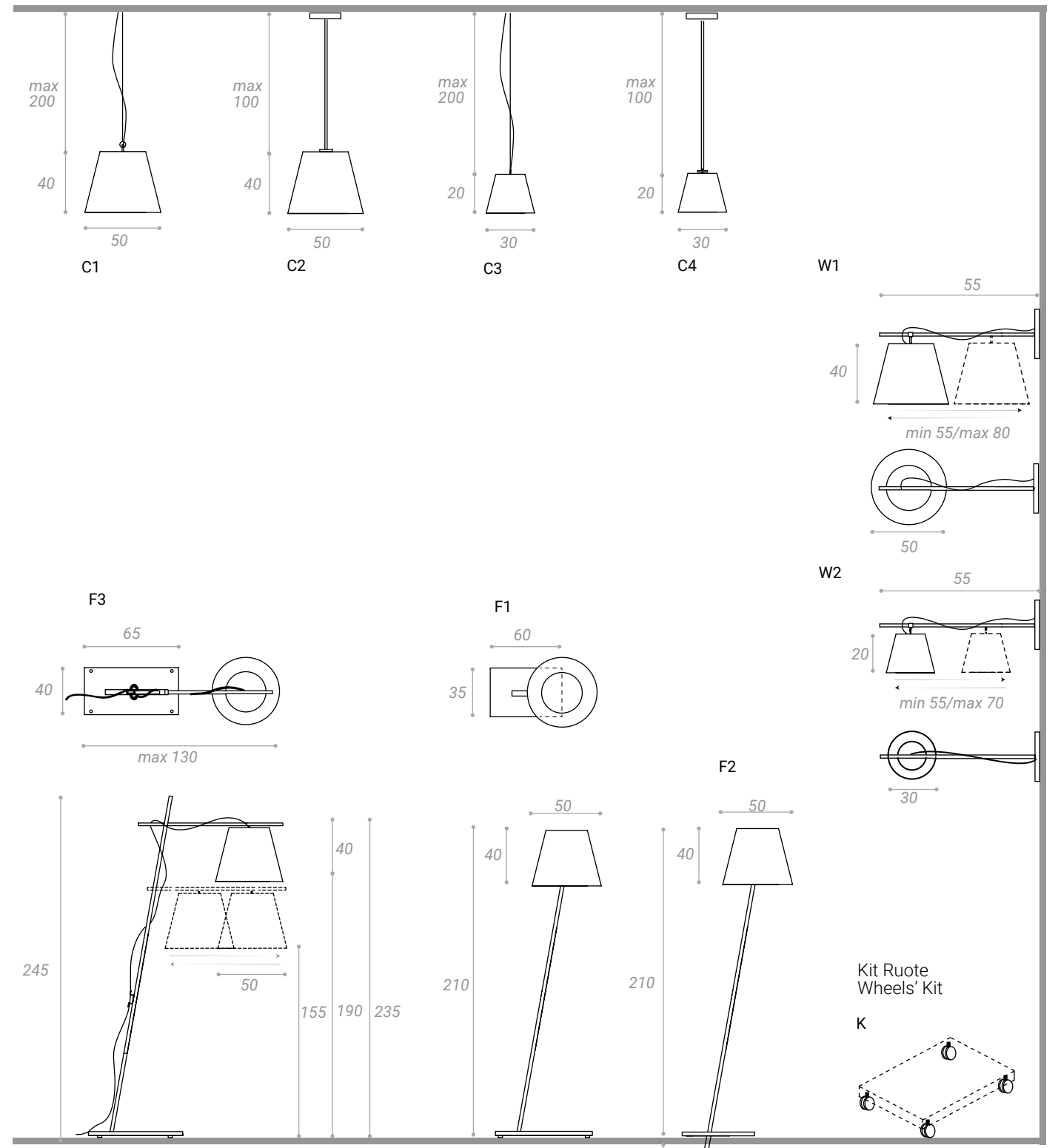

MATERIALE/MATERIAL  
fibra di vetro/fiberglass

FINITURE/  
FINISHES

MATERIALE PER STRUTTURA/  
MATERIAL FOR STRUCTURE

MATERIALE PER LA BASE/  
MATERIAL FOR THE BASE

ACCIAIO INOX/  
STAINLESS STEEL

OTTONE/  
BRASS

SERIZZO/  
STONE

LAVA/  
LAVA

- C1
  - C2
  - C3
  - C4
  - W1
  - W2
  - F2
  - F3
- E27 20W 2500Lm 110/230V





# REGOLO

design Gianfranco Marabese 2017



Spot ad alta prestazione, che offre una luce puntuale, mirata. La parte anteriore del piccolo diffusore si sposta come un obiettivo fotografico e modifica il diametro dei coni luminosi, consentendo di incorniciare ed evidenziare dettagli del paesaggio: senza abbagliare, con discrezione.

High performance spotlight, offering a focused, targeted light. The front of the small diffuser moves like a photographic lens and changes the diameter of the light cones, allowing you to frame and highlight details of the landscape: discreetly without dazzling.

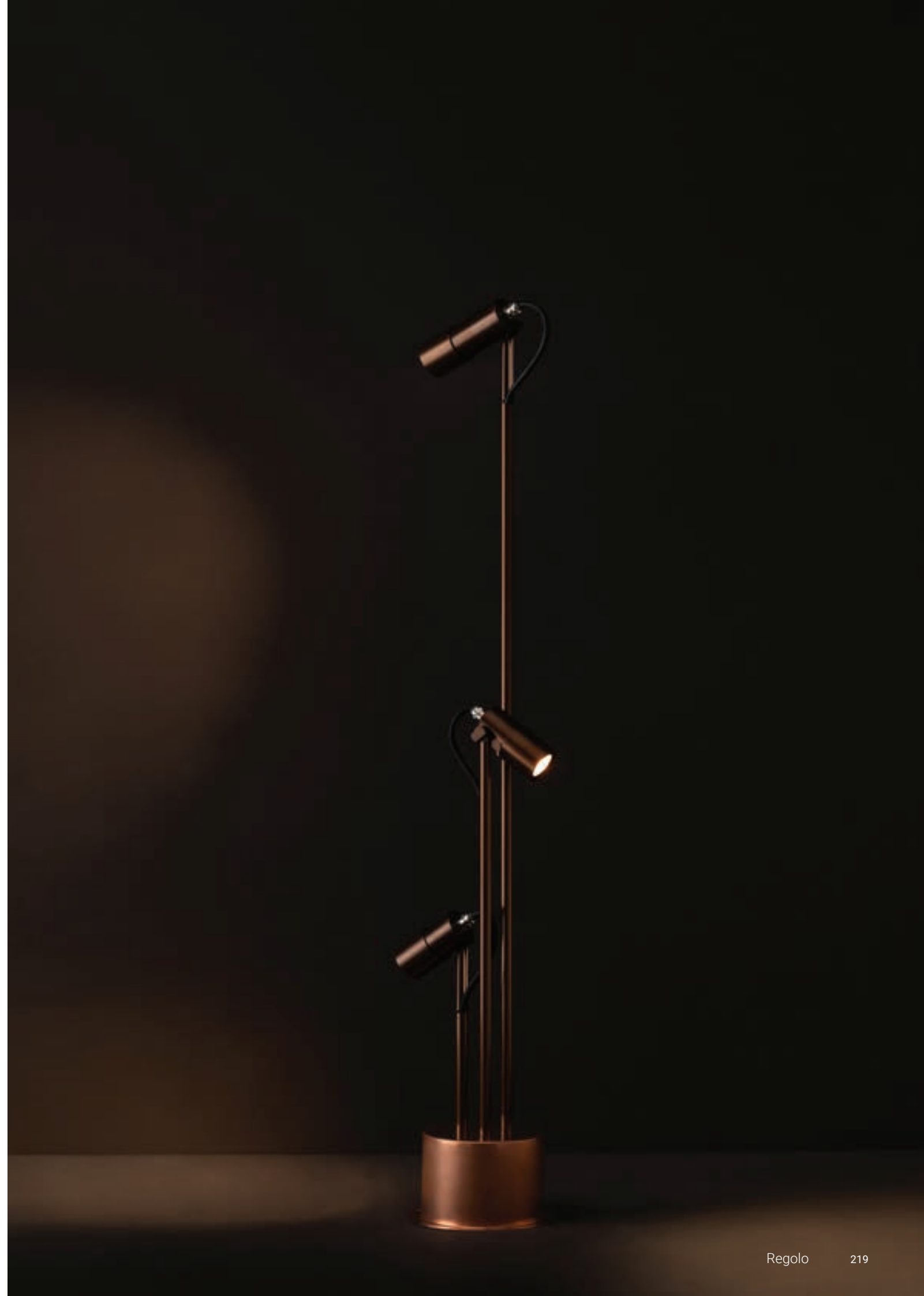







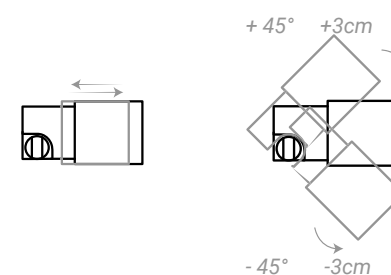
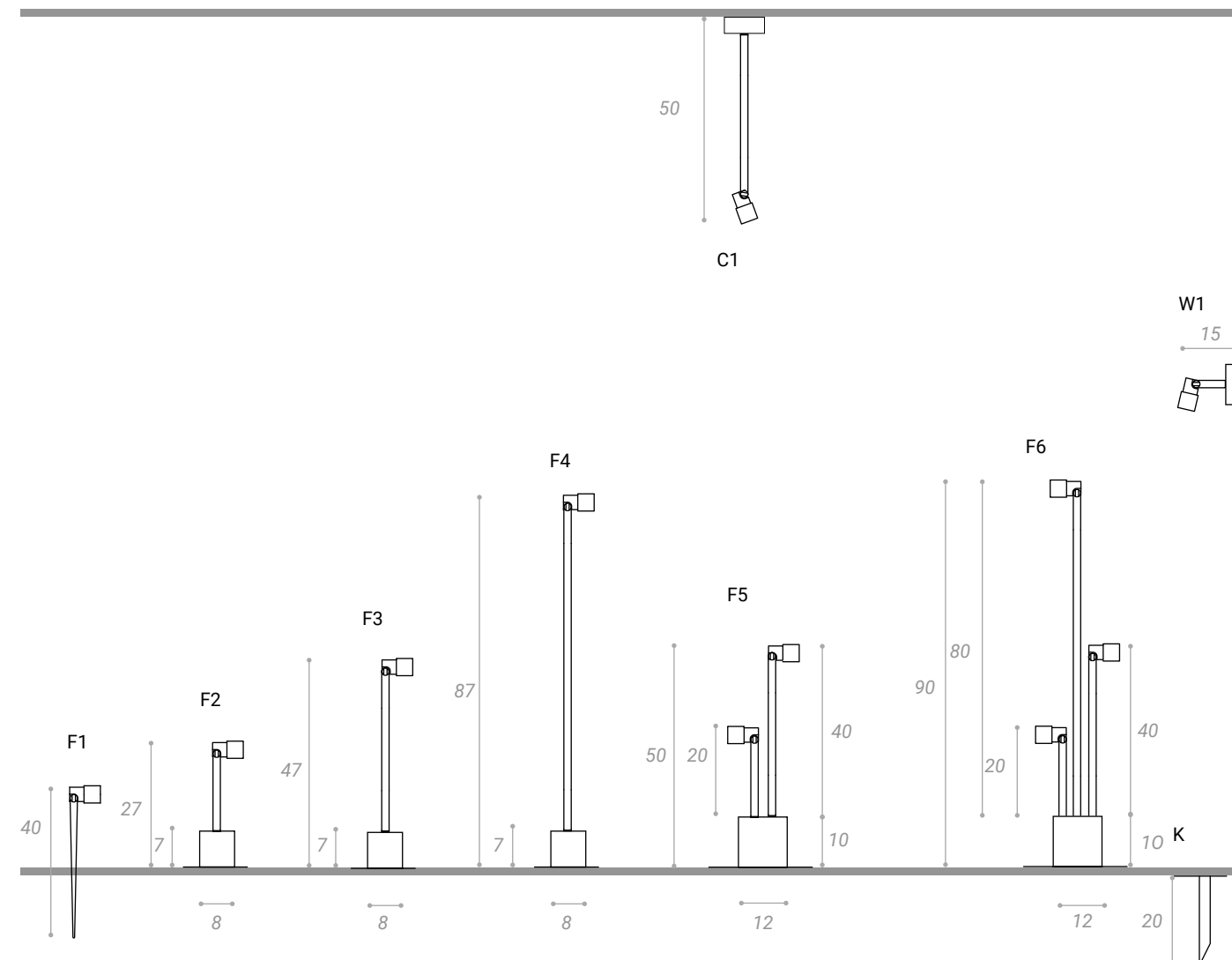

F1	1x Led 1W 220Lm 350mA	Remote driver	∠ 20° to 40°	
C1	1x Led 1W 220Lm 350mA	Driver included	∠ 20° to 40°	
F2	1x Led 1W 220Lm 350mA	Driver included	∠ 20° to 40°	Picket optional
F3				
F4	2x Led 1W 440Lm 350mA	Driver included	∠ 20° to 40°	Picket optional
F5				
F6	3x Led 1W 660Lm 350mA	Driver included	∠ 20° to 40°	Picket optional

MATERIALE/MATERIAL  
alluminio/aluminium

FINITURE/  
FINISHES

CE F1  
CE C1/F2/F3/F4/F5/F6/W1

BRONZO/  
BRONZE



# RICAMI

design Gianfranco Marabese 2009



Collezione di lampade a paralume, con diffusore in fibra di vetro bianco caldo, di diverse dimensioni e soluzioni tipologiche: resistente all'urto, lavabile, di facile manutenzione. Un cilindro di vetro borosilicato, all'interno del paralume, avvolge e scherma le fonti luminose per evitare abbagliamenti.

Collection of lampshades with diffuser in warm white fibreglass, of different sizes and typological solutions: impact resistant, washable, easy to maintain. A cylinder of borosilicate glass, inside the lampshade, wraps and screens light sources to avoid dazzling.











C3 } E27 20W 2500Lm    
 C4 }  
 F7 } E27 20W 2500Lm   
 F8 }  
 T2 }



MATERIALE/MATERIAL  
metallo/metal

FIBRA DI VETRO/  
FIBERGLASS



FINITURE/  
FINISHES

BIANCO/  
WHITE



BRONZO/  
BRONZE



MATERIALE PER LA BASE/  
MATERIAL FOR THE BASE

LAVA/  
LAVA





# FLAMBEAU

design Giordana Arcesilai 2017



Lampada da appoggio o da sospendere, ricaricabile, per un funzionamento autonomo, senza fili.  
La raffinata lavorazione in ottone, acciaio e rame, fa filtrare la luce in modo suggestivo, creando effetti luminosi fortemente emozionali.

Standing or hanging lamp, rechargeable, for an autonomous wireless functioning. The refined workmanship in brass, steel or copper, filters the light in a suggestive way, creating highly emotional lighting effects.





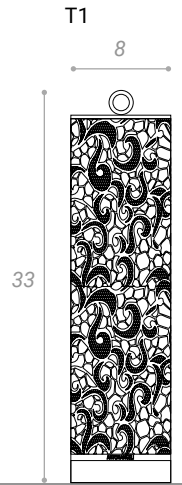

RICARICABILE. 12 Ore di luce senza fili  
RECHARGEABLE. 12 Hours of wireless light

MATERIALE/MATERIAL  
metallo/metal

FINITURE/  
FINISHES

ACCIAIO/  
STEEL



OTTONE/  
BRASS



RAME/  
COPPER



T1 Led 4W 400Lm 3000°K





# I SNAP

R&S Antonangeli 2007



Lampada costituita da una asta in rame duttile, che permette di direzionare la luce a LED ed ottenere gli effetti luminosi desiderati. Utilizzabile singolarmente o in aggregato, per esilità visiva e dimensioni della fonte luminosa, è ideale per l'illuminazione di piante in vaso o cespugli. Il rame, non trattato, grazie alla naturale ossidazione, consente un'integrazione formale e visiva con il paesaggio.

Lamp consisting of a ductile copper rod, which allows to direct the LED light and obtain the desired lighting effects. It can be used singularly or in aggregate, due to the visual slenderness and size of the light source, it is ideal for lighting potted plants or bushes. Untreated copper, thanks to natural oxidation, allows formal and visual integration with the landscape.





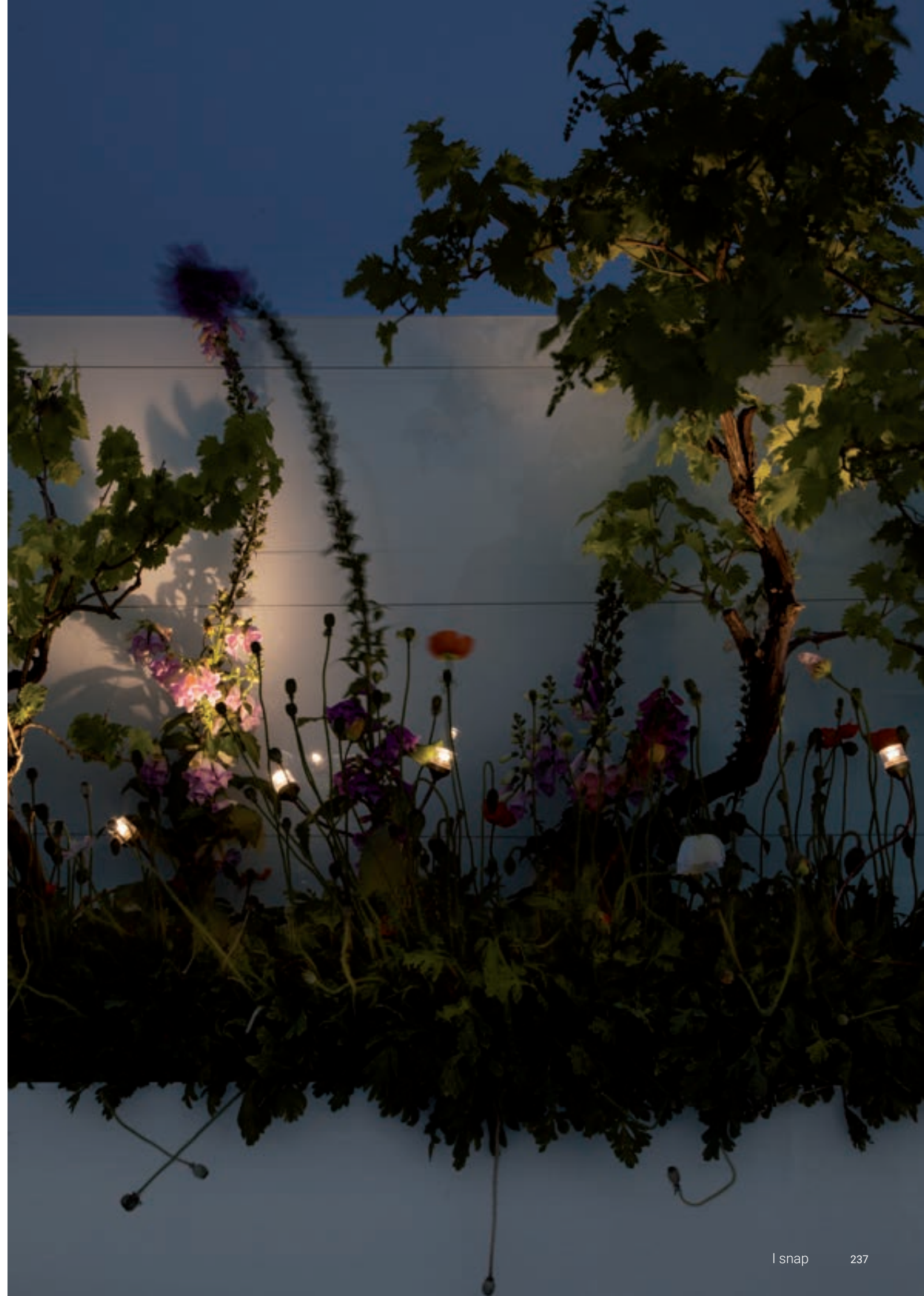
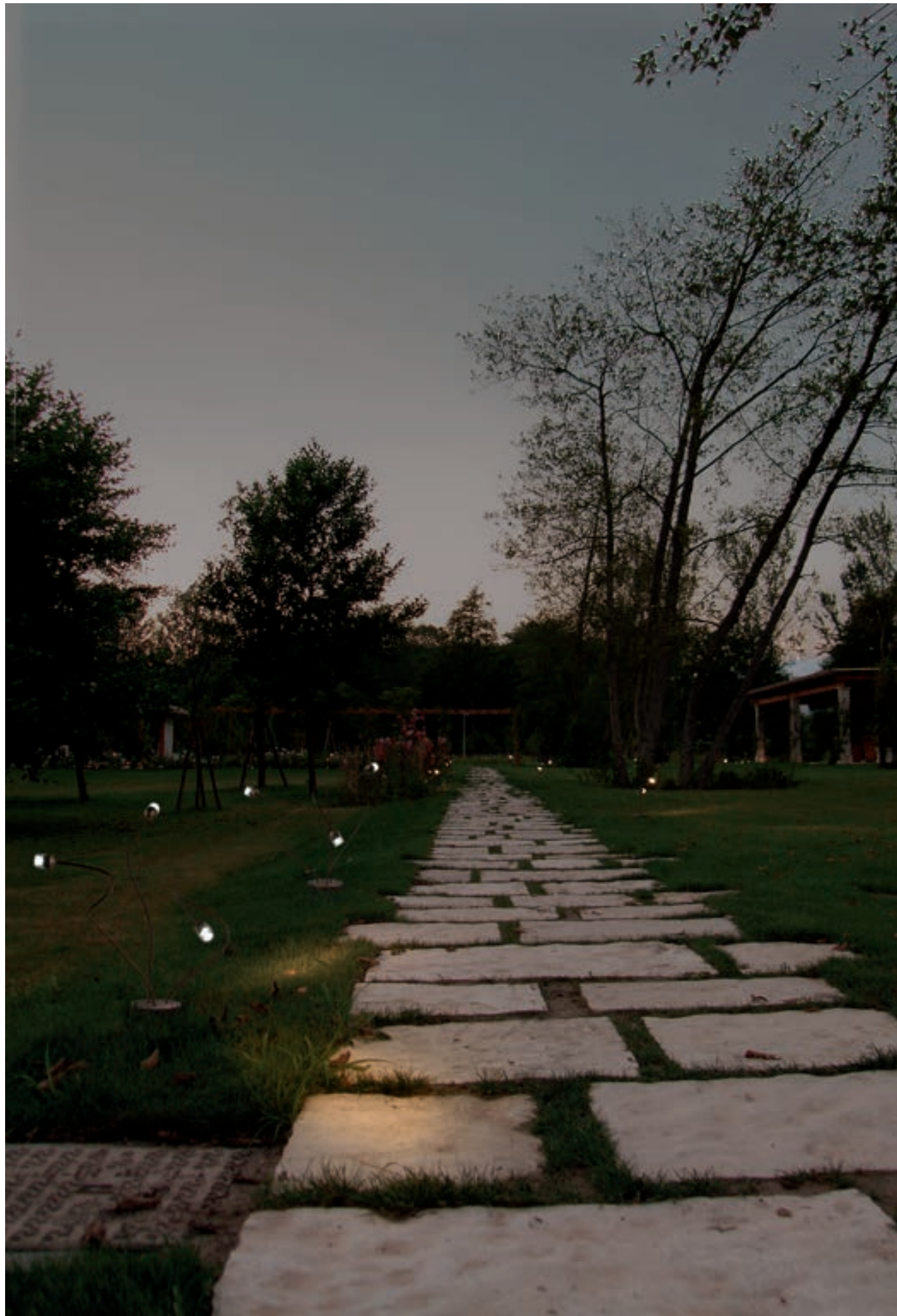



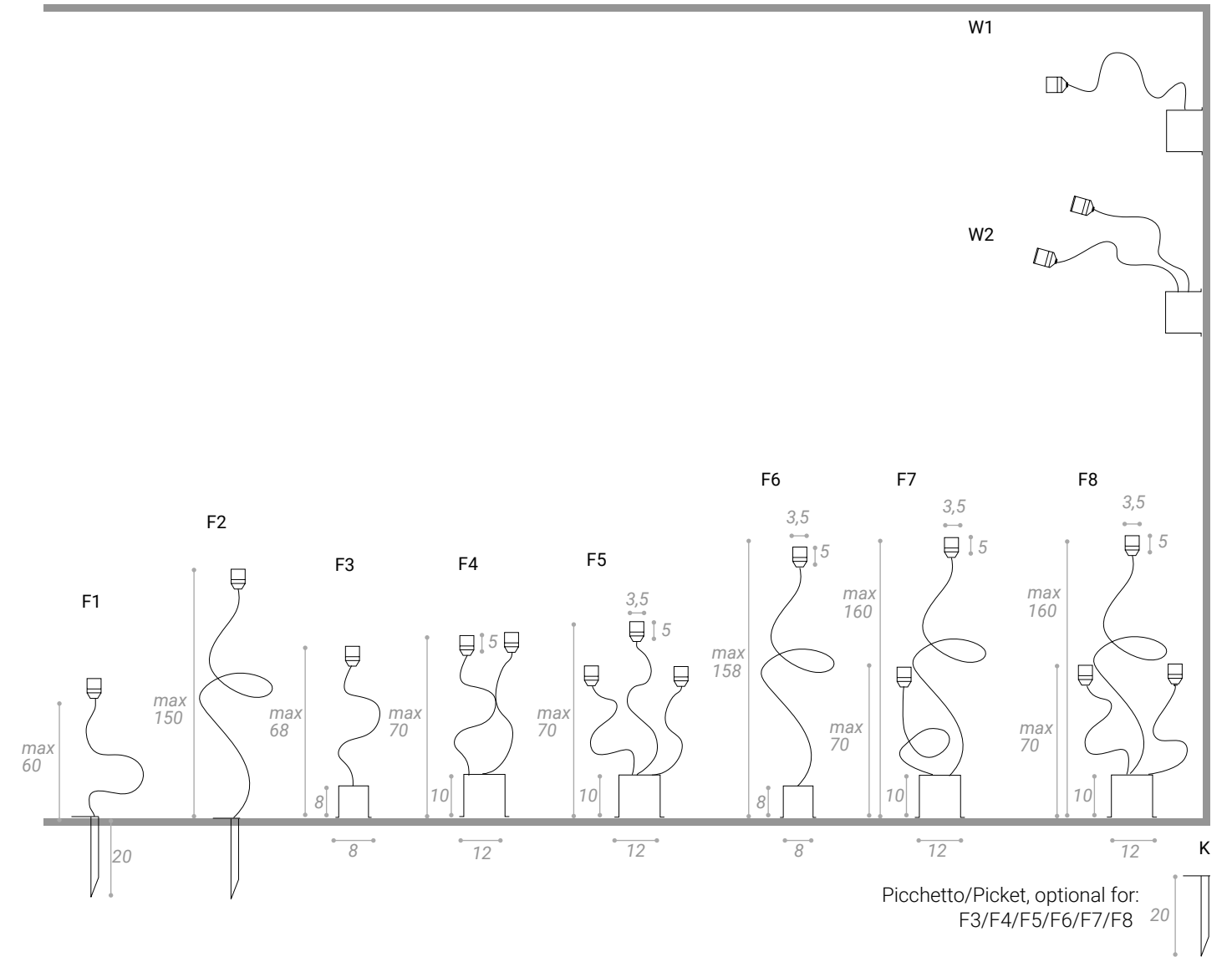

LED: 3000°K-2700°K  
BIANCO/WHITE  
BLU/BLUE

MATERIALE/MATERIAL  
rame/copper

FINITURE/  
FINISHES



W1	Led 3W 160Lm 700mA	Driver included
W2	2x Led 3W 160Lm 700mA	Driver included
F1	Led 3W 160Lm 700mA	Remote driver
F2		
F3	Led 3W 160Lm 700mA	Driver included
F6	2x Led 3W 160Lm 700mA	Driver included
F4		
F7		
F5	3x Led 3W 160Lm 700mA	Driver included
F8		

CE F1/F2  
CE F3/F4/F5/F6/F7/F8/W1/W2

# POLLICINO

design Giordana Arcesiali 2007



Lampada che nasce come segna-passo e luce d'accento orientabile per evidenziare alberi, sculture, architetture. Si utilizza appoggiata al suolo, singolarmente o collegata in sequenza. Può essere impiegata anche in interno, come luce di cortesia o come accento per le piante in vaso.

Lamp that was born as a step-maker and adjustable accent light to highlight trees, sculptures, architectures. It is used resting on the ground, singularly or connected in sequence. It can also be used indoors, as a courtesy light or as an accent for potted plants.





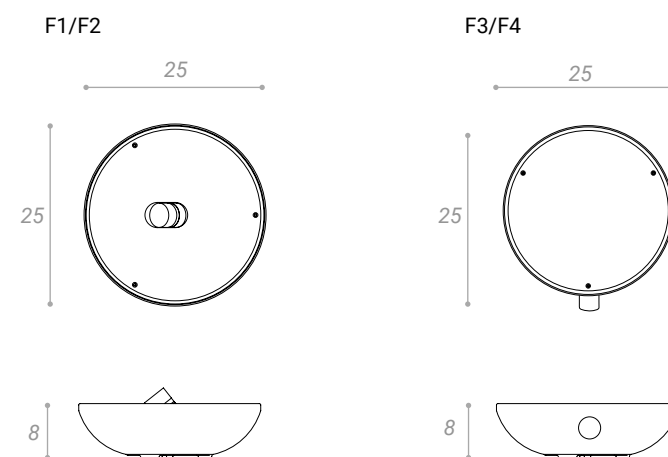

F1 }  
 F2 } 2x Led 350mA 1W cad. Remote driver  
 F3 }  
 F4 }

LED: 3000°K-2700°K  
 BIANCA/WHITE  
 BLU/BLE

MATERIALE/MATERIAL  
 alluminio/aluminium

FINITURE/  
 FINISHES

ALLUMINIO F1,F3/  
 ALUMINIUM F1, F3

BRONZO F2, F4/  
 BRONZE F2, F4





# CONCRETA

design Sara Moroni 2021



Monolite in cemento colato per gravità, ospita all'interno la fonte luminosa: una luce morbida per evidenziare superfici, vegetazione, percorsi. La forma, la materia e le colorazioni ottenute in 'masse', permettono a Concreta inserimenti in contesti diversi, rispettando natura e architettura.

Monolith in gravity-cast concrete, it houses the light source inside: a soft light to highlight surfaces, vegetation, paths. The shape, the material and the colors obtained 'en masse' allow Concreta to be positioned in different contexts, respecting nature and architecture.





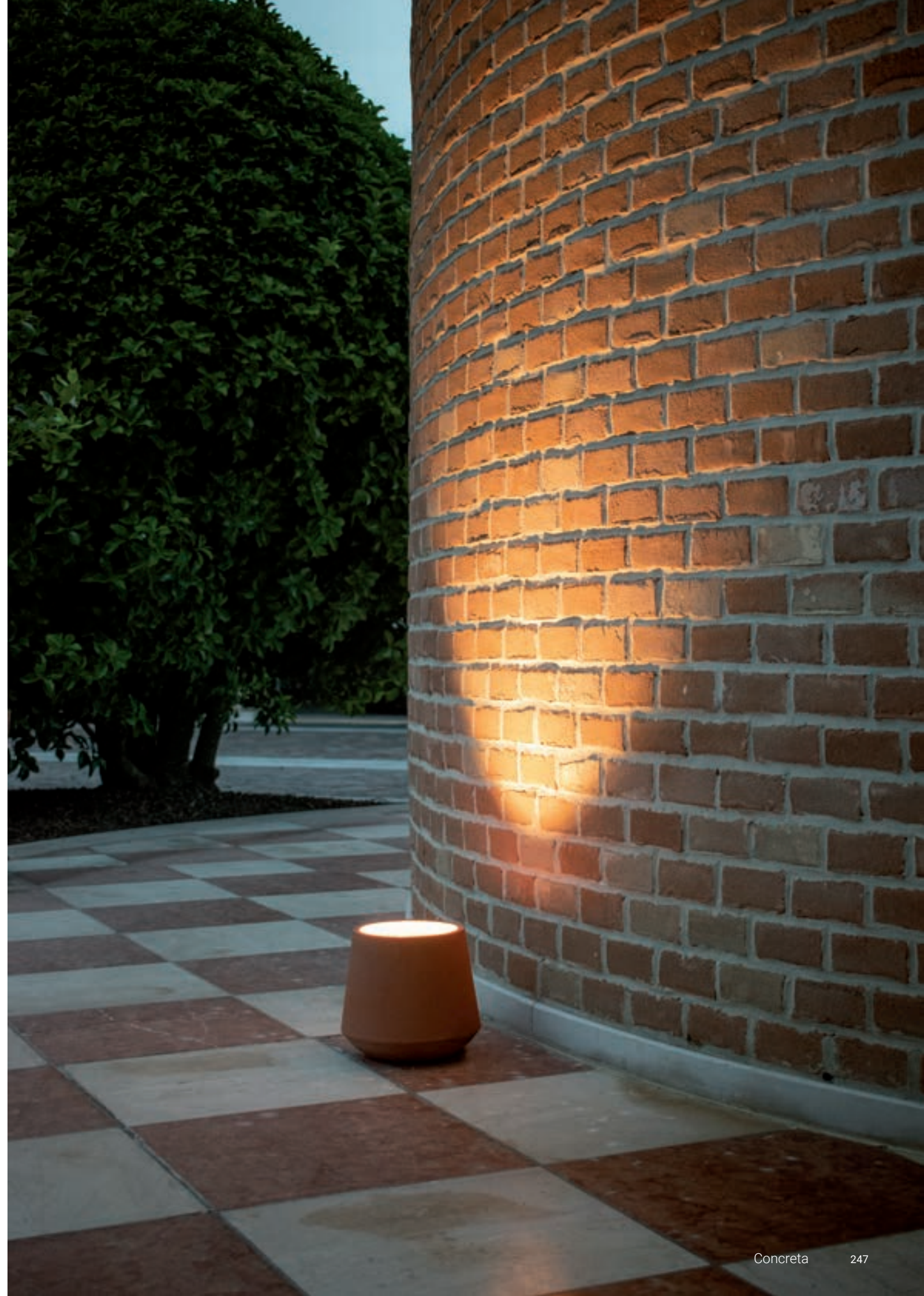



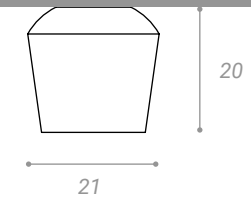

C1

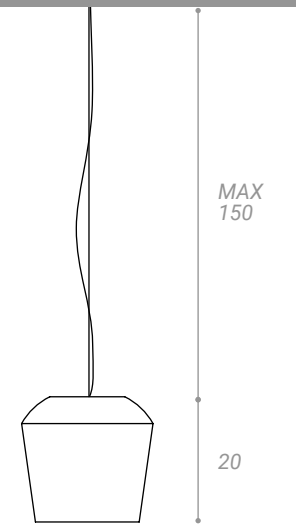

C2

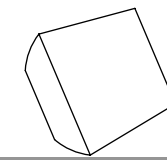

F1

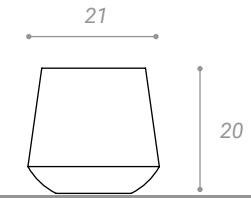

C1 }  
C2 } GU10  
F1 }



MATERIALE/MATERIAL  
cemento colato/gravity-cast concrete

FINITURE/  
FINISHES

CEMENTO TERRACOTTA/  
TERRACOTTA CONCRETE



CEMENTO NATURALE/  
NATURAL CONCRETE



CEMENTO GRAFITE/  
GRAPHITE CONCRETE





# GIUNCO

design Albero-Monti 2016



Sottili canne di rame naturale con diffusore in vetro satinato, evocano la luce d'atmosfera delle piccole lanterne, inserendosi nella vegetazione con discrezione.

Thin natural copper rods, with a satinated glass evoke the mood of small lantern's light, inserting itself into the vegetation discreetly.

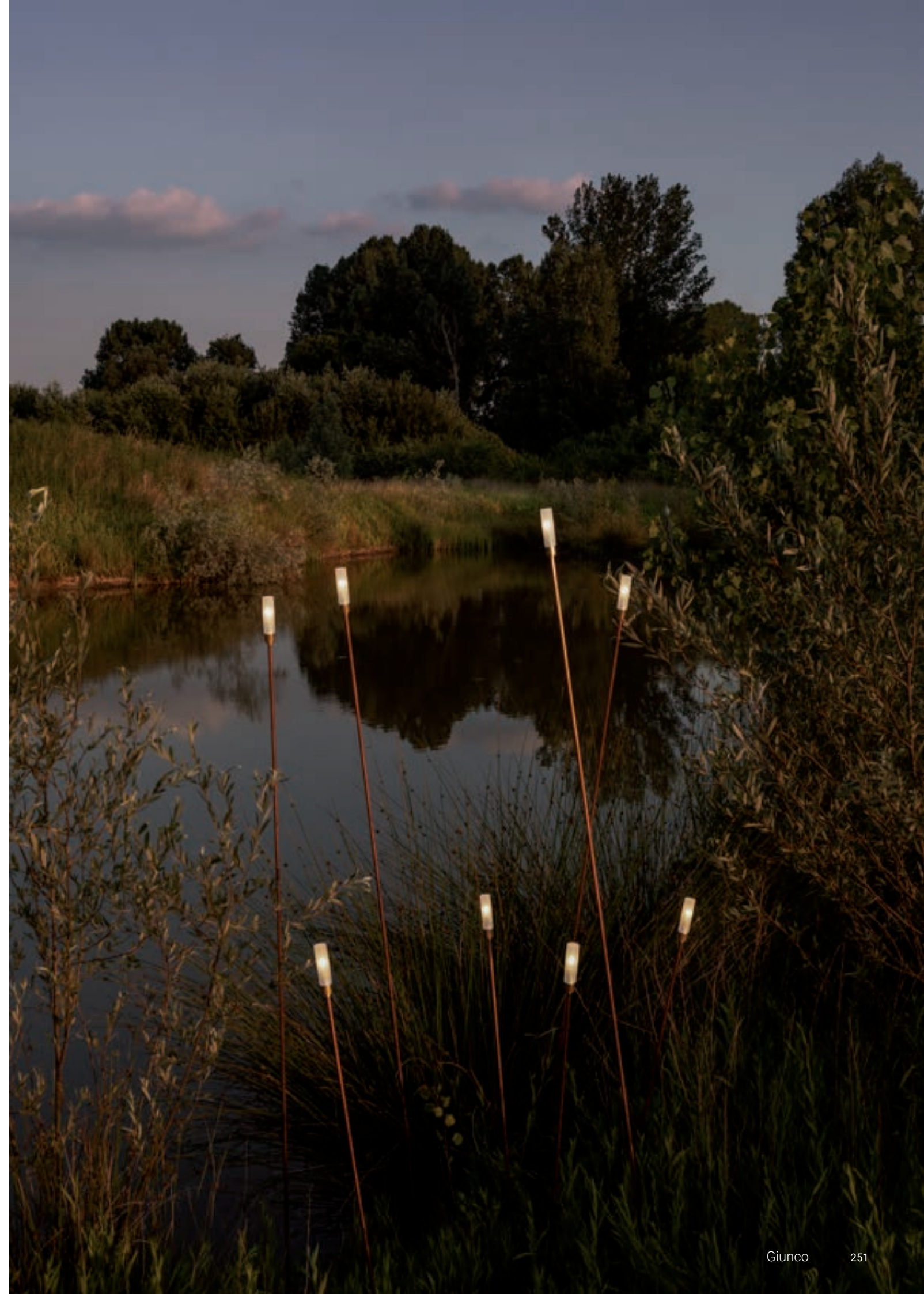







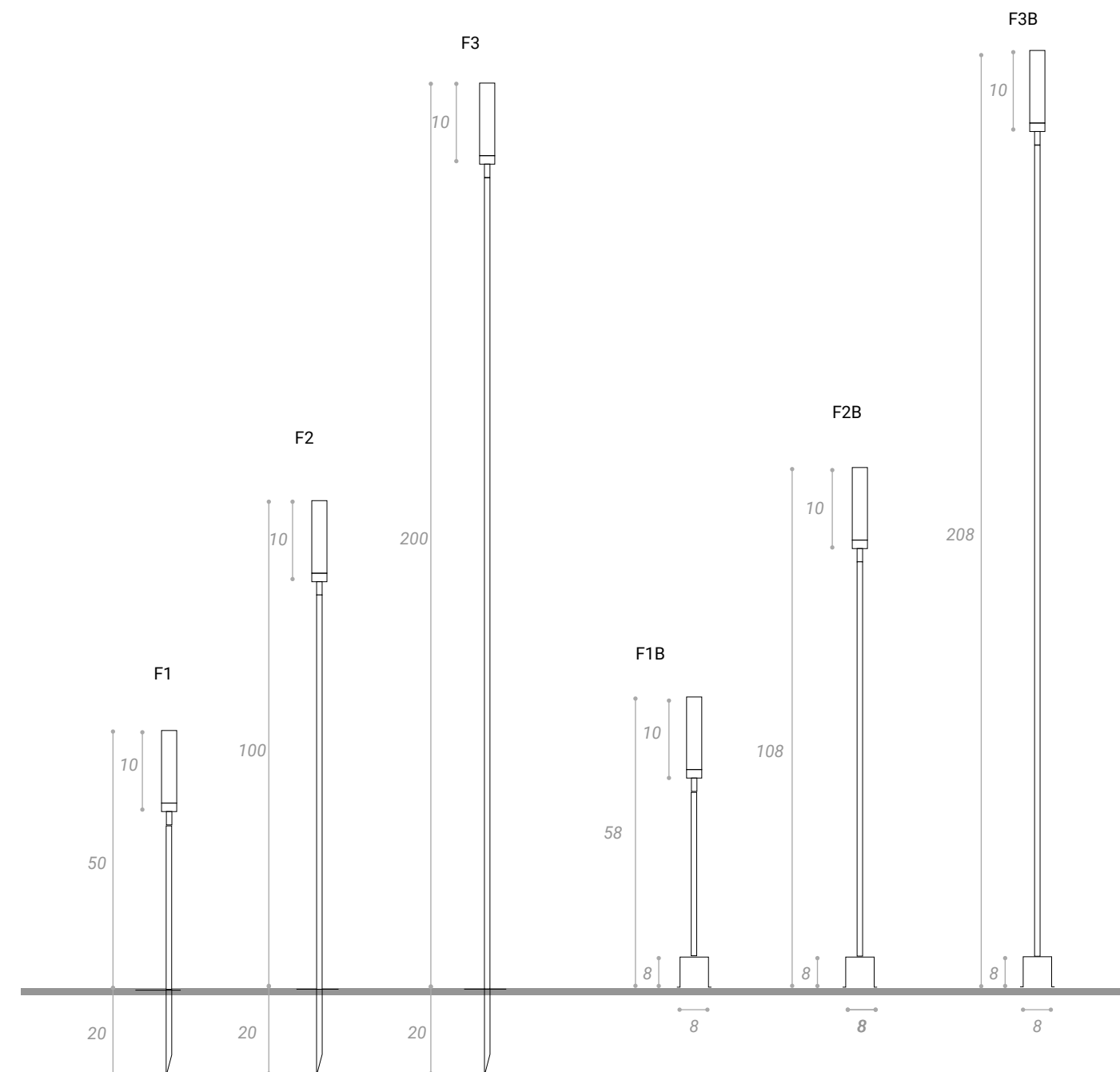

- F1
  - F1B
  - F2
  - F2B
  - F3
  - F3B
- Led G9 110/230V 4W 280Lm 3000°k

MATERIALE/MATERIAL  
rame/copper  
pirex/pirex

FINITURE/  
FINISHES



RAMME/  
COPPER



# LIBERA

design Gianfranco Marabese 2016

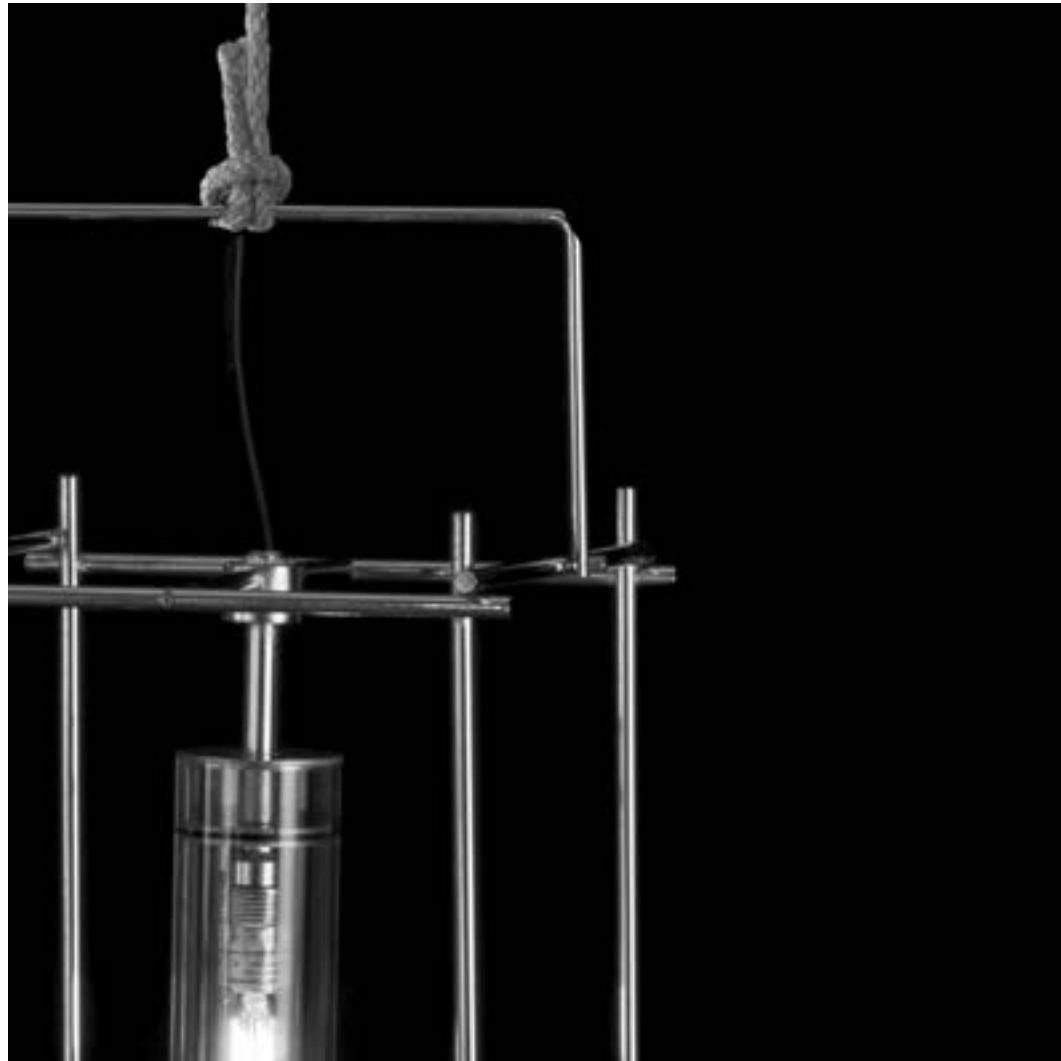

Lantern in tre dimensioni, con fonte luminosa ad effetto galleggiante grazie al suo posizionamento all'interno del sottile perimetro di metallo, che ne definisce la forma.

Lantern in three dimensions, with a floating effect light source thanks to its positioning within the thin metal perimeter, which defines its shape.





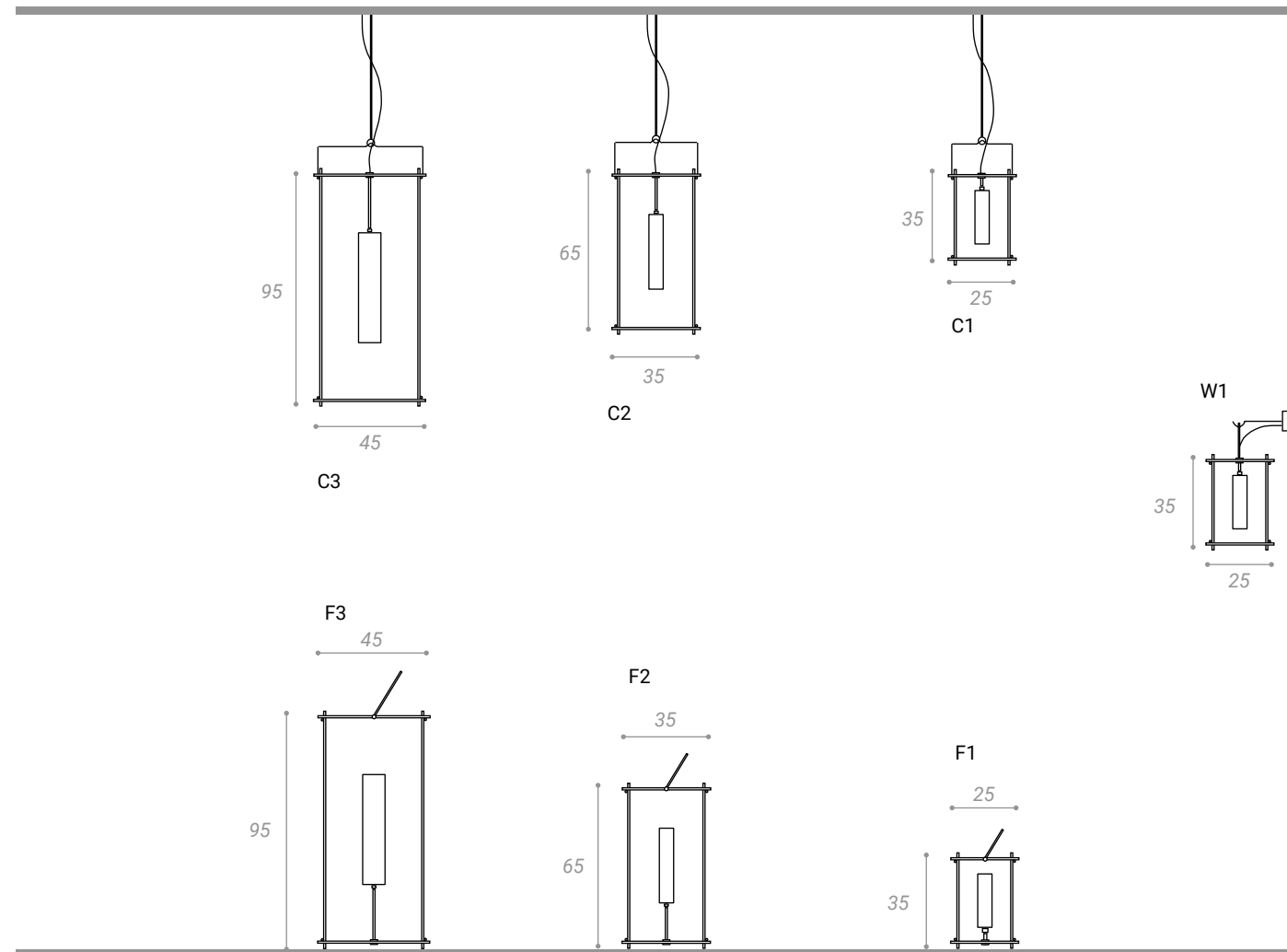

- C1 } E14 6W 470Lm
- C2 } E14 6W 470Lm
- C3 } E27 20W 2500Lm
- F1 } E14 6W 470Lm
- F2 } E14 6W 470Lm
- F3 } E27 20W 2500Lm
- W1 } E14 6W 470Lm

MATERIALI/MATERIALS  
metallo/metal

FINITURE/  
FINISHES

- BIANCO/  
METAL
- BRONZO/  
BRONZE
- OTTONE/  
BRASS





# SOUL

design Romeo Guaricci 2019



Collezione che traduce forme conosciute, in un oggetto dal segno innovativo, esclusivo, in grado di personalizzare ogni tipo di ambiente. La luce che diffonde, nasce dal contrasto tra volume e trasparenza, nell'accordo tra l'originale rivestimento a 'tricot' e lo scheletro in metallo che la sostiene.

Collection that translate iconic shapes into an object with an innovative, exclusive sign, able to personalize any type of environment. The light that it diffuses comes from the contrast between volume and transparency, in the agreement between the original "tricot" coating and the metal structure that supports it.









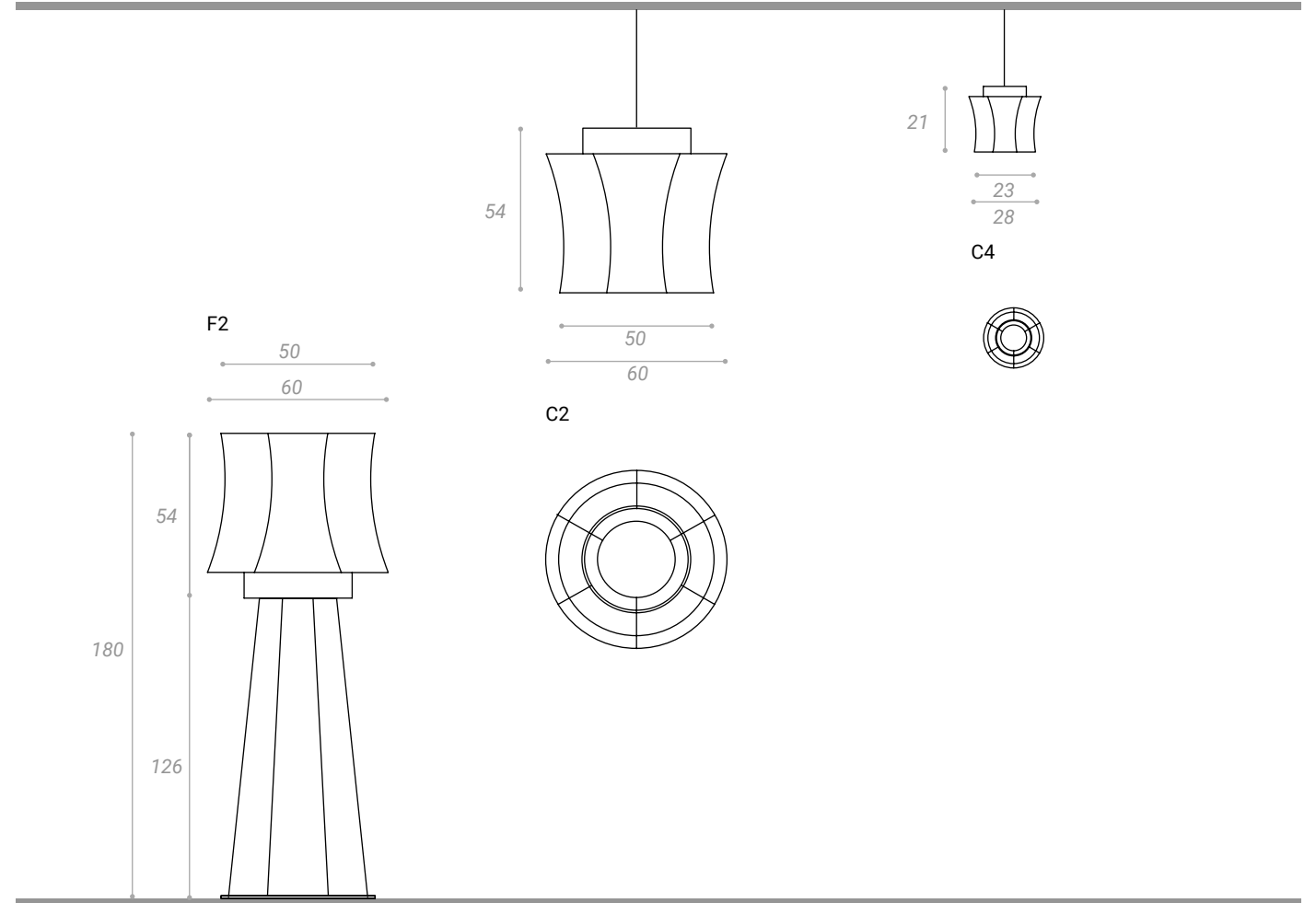
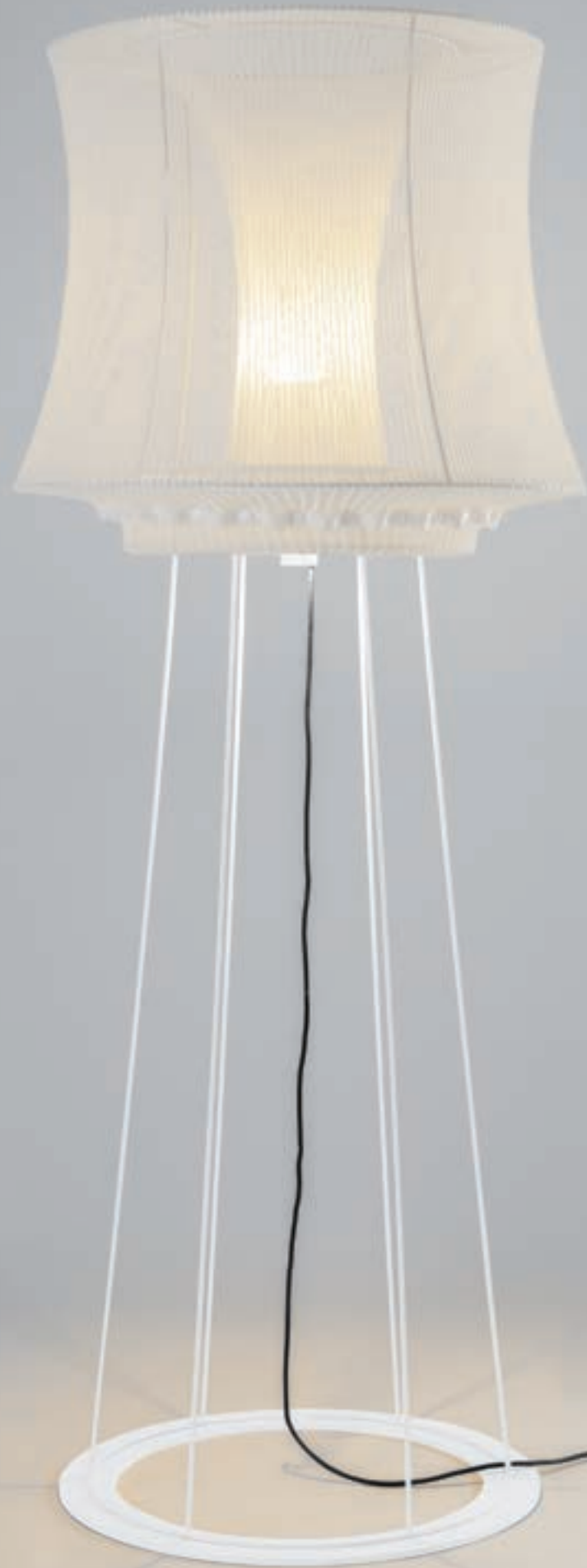

- F2 E27 2550Lm
- C2 E27 2550Lm
- C4 G9



MATERIALI/MATERIAL  
filo vinile/vinyl thread  
metallo/metal

FINITURE/  
FINISHES

BIANCO/  
WHITE

BRONZO/  
BRONZE

ROSSO/  
RED

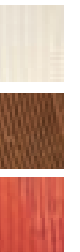



# CU-BOX

design Gianfranco Marabese 2016



Cu-box è un proiettore a luce diretta, di dimensioni contenute, utilizzabile a parete e da terra in versione orientabile, per illuminare con discrezione e precisione, senza abbagliare.

Cu-box is a direct light projector with small dimensions, which can be used on the wall and on the floor in adjustable version, to illuminate discreetly without glare.









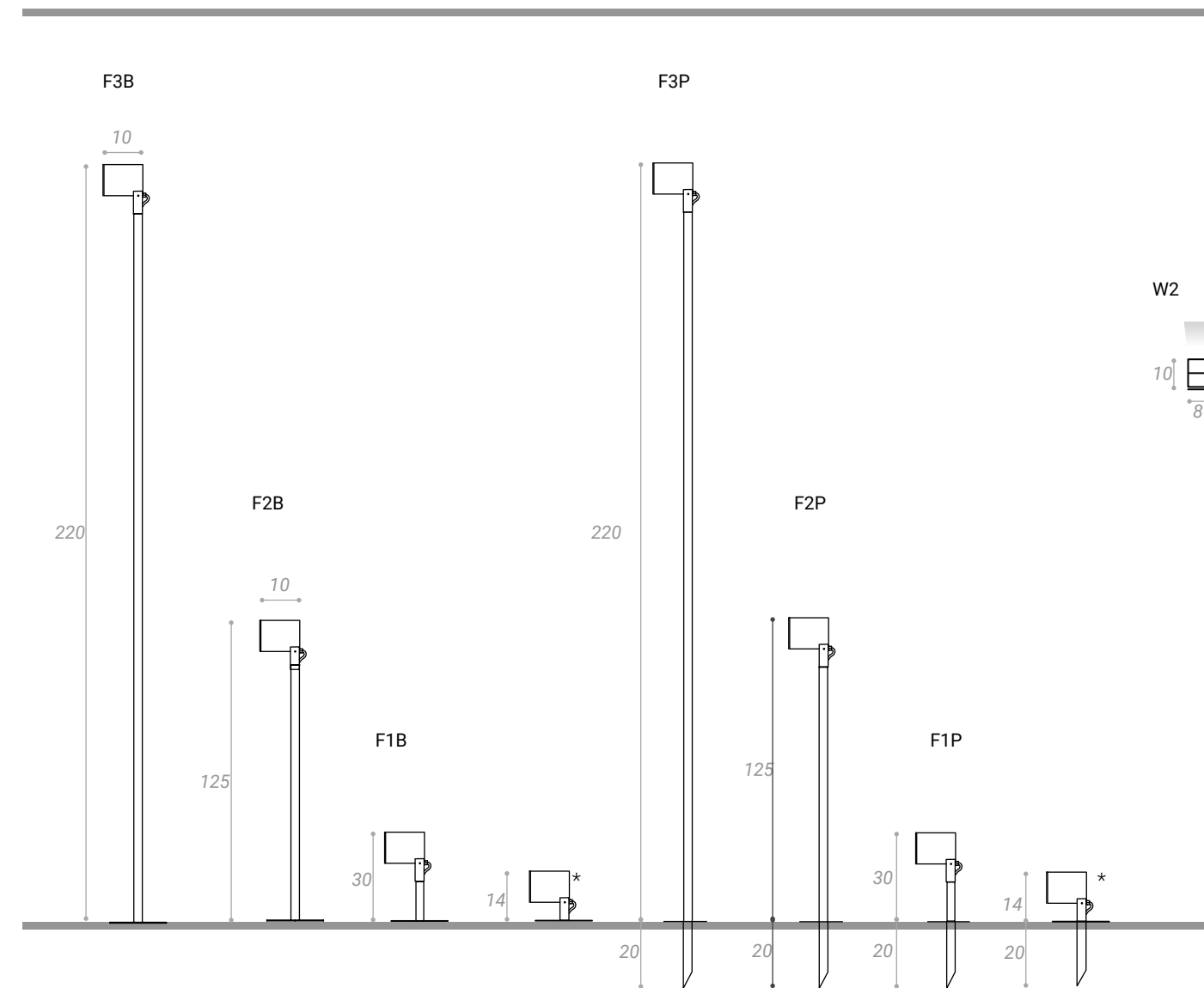

MATERIALE/MATERIAL  
alluminio/aluminium

FINITURE/  
FINISHES

BIANCO/  
WHITE

BRONZO/  
BRONZE

NERO/  
BLACK



- F1B
  - F2B
  - F3B
  - F1P
  - F2P
  - F3P
- W2 Led 12W 350mA 3000°k 1500Lm Remote driver
- W2 Led 12W 350mA 3000°k 1500Lm Driver included

CE 40° F1B/F2B/F3B/F1P/F2P/F3P

CE 40° W2



# PULCINELLA

design Giordana Arcesilai 2009

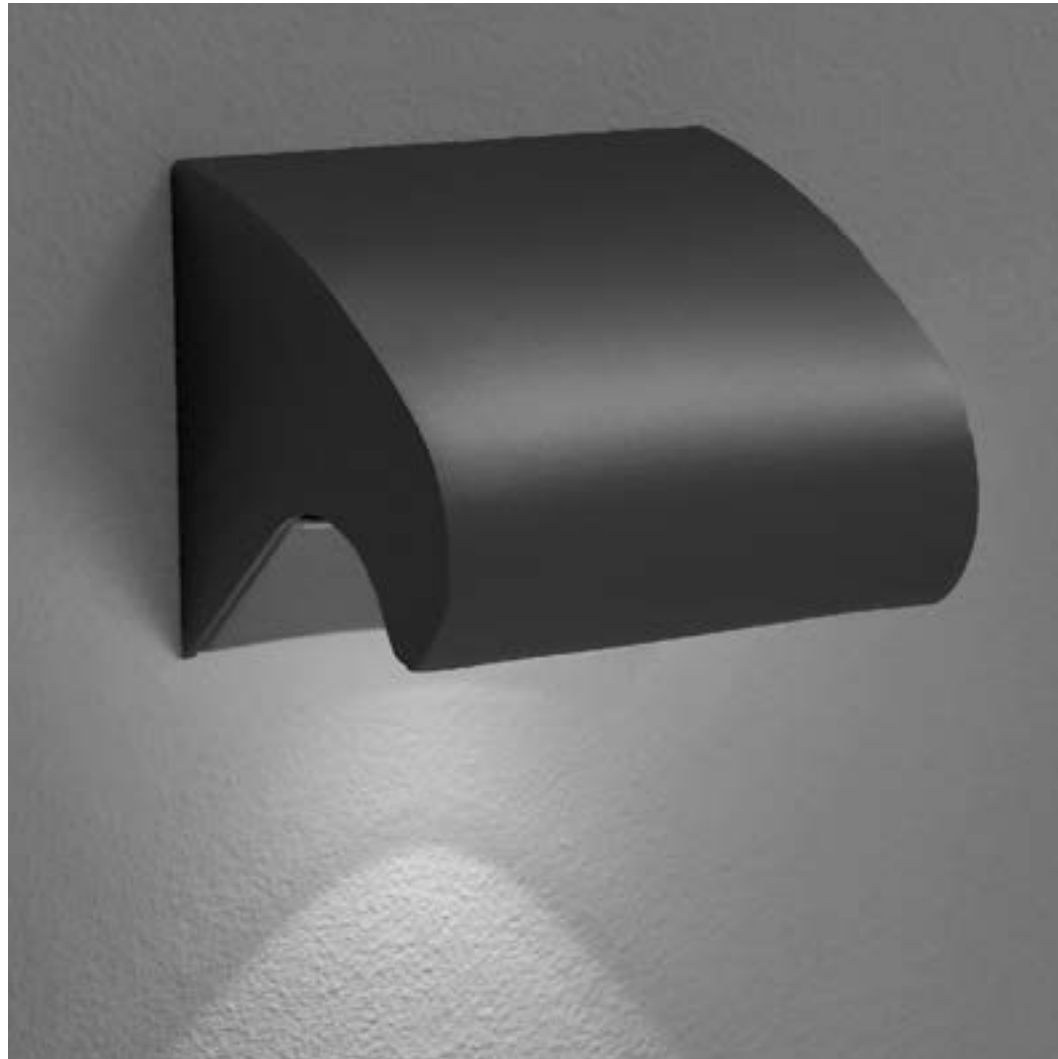

Segna passo da installare a parete, che nella sua morbida forma incorpora la tecnologia LED, con alimentatore incluso. Pensato per risolvere progetti di illuminazione in cui non è possibile la soluzione ad incasso.

Mark step to be installed on the wall, which incorporates LED technology in its soft form, with driver included. Designed to solve lighting projects where a recessed solution is not possible.

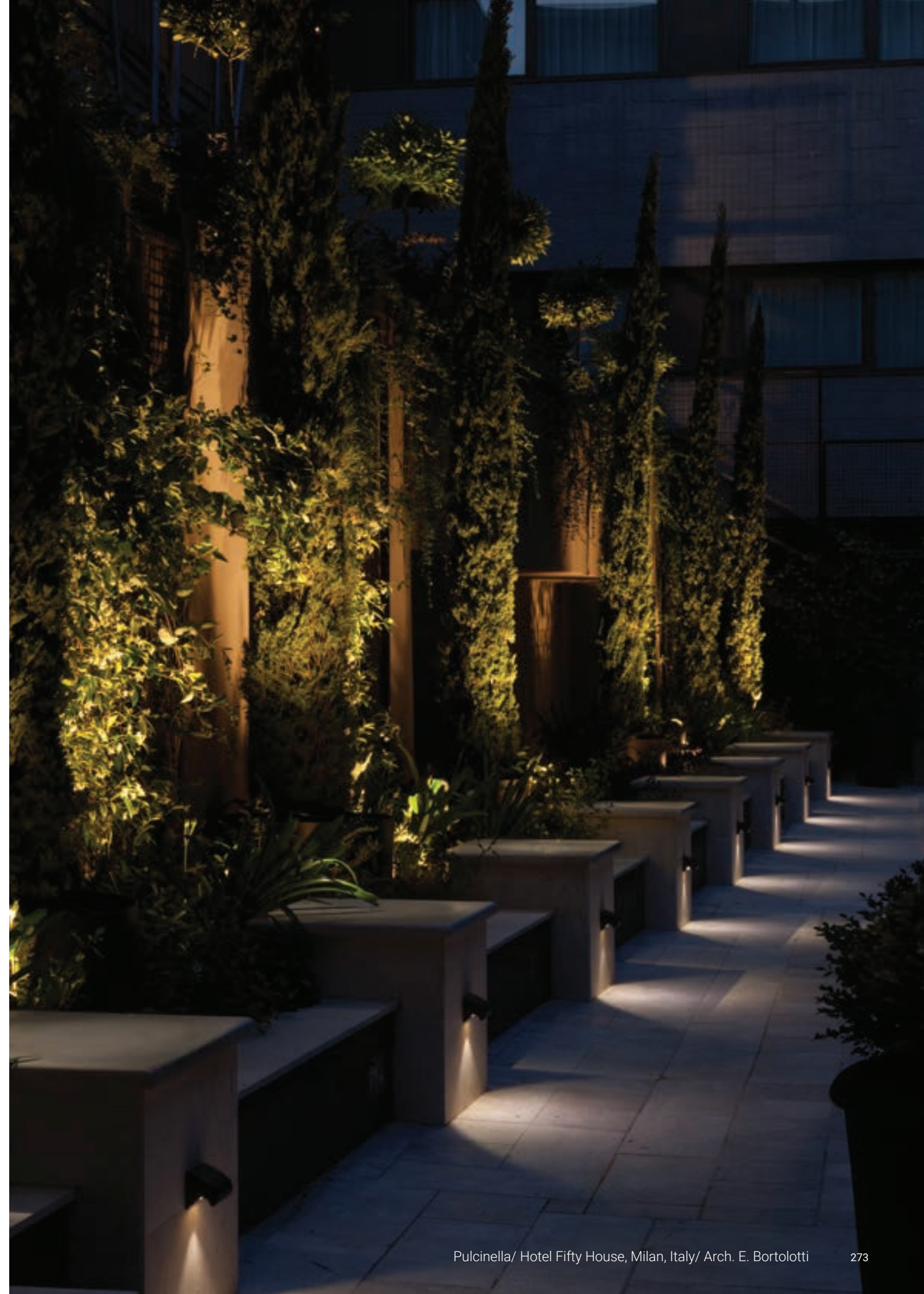



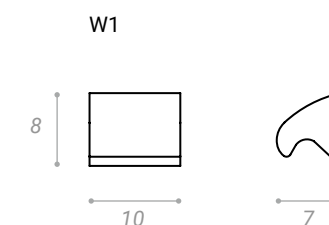

W1 Led 1W 350mA 3000°k 105Lm Driver included



MATERIALE/MATERIAL  
alluminio/aluminium  
metallo/metal

FINITURE/  
FINISHES

ALLUMINIO/  
ALUMINIUM

BIANCO/  
WHITE

BRONZO/  
BRONZE





# NOTTAMBULA

design Gianfranco Marabese 2009



Lantern in white warm fiberglass of contained dimensions, that creates in outdoor spaces, intimate atmospheres. The high resistance to impacts, bad weather and the ease of cleaning, allow an easy and convenient use in any context.

A small, warm white fiberglass lantern that creates intimate atmospheres in outdoor spaces. The high resistance to impacts, bad weather and its ease of cleaning allow an easy and convenient use in any context.





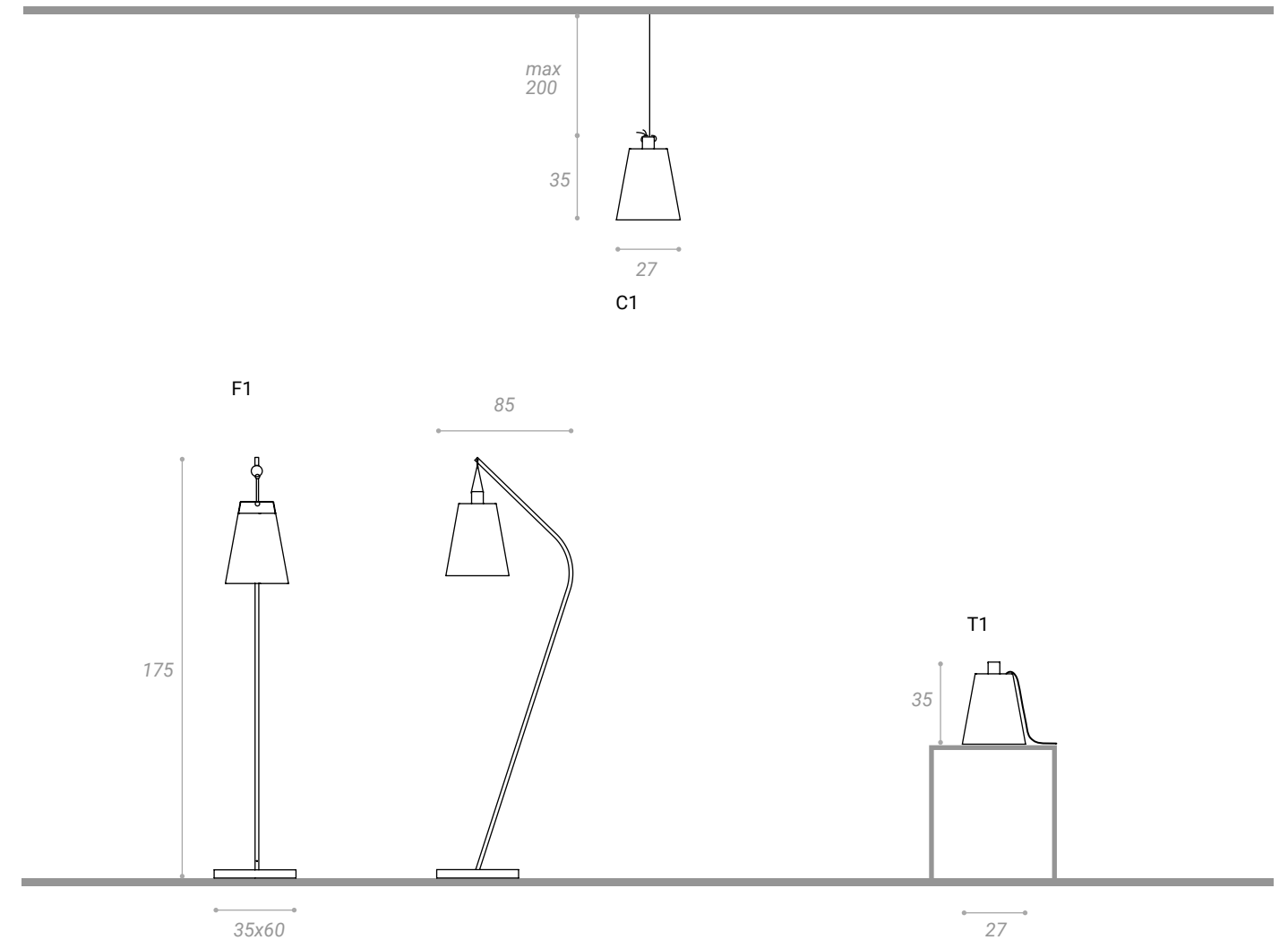

MATERIALI/  
MATERIAL

FIBRA DI VETRO/  
FIBERGLASS

RAME/  
COPPER

MATERIALE PER LA BASE/  
MATERIAL FOR THE BASE

LAVA/  
LAVA

C1 }  
F1 } G9 110/230V 3000°k 280Lm  
T1 }



#### LEGENDA/LEGEND

I Prodotti Antonangeli sono contrassegnati da simboli indicanti conformità a norme di sicurezza internazionale, generali o riferite a particolari condizioni applicative/Antonangeli's products are marked by symbols conforming to International, general safety rules or concerning those particular conditions



Prodotto rispondente alle Direttive Comunitarie Europee/ It certicates the conformity of the product according to the European Community Directives.



Apparecchio omologato in Classe 1 dotato di messa a terra. In assenza di indicazioni, l'apparecchio è inteso in Classe 1/ Class 1 appliance fitted with basic insulation. Accessible conductors are earthned.



Apparecchio omologato in Classe II, con cablaggio a doppio isolamento/ Class II appliance fitted with double insulation or reinforced insulation



Alimentazione a bassissima tensione di sicurezza. Tensioni superiori a 50V (a 50Hz) escluse. Esclusa messa a terra/ Very low safety supply voltage. Not to be used at over 50V (at 50Hz). Earthning excluded



Apparecchio adatto al montaggio diretto su superfici normalmente infiammabili/ With built-in power packs or transformers ready for mounting on normally flammablee surface.



Distanza minima dagli oggetti illuminati/ Minimum distance from illuminated objects



Apparecchio dimmerabile. Dove presente la dicitura "su richiesta" , l'apparecchio è acquistabile con sistema dimmer/ Dimmable lamp. Where the words 'on demand' appear, the lamp is affordable with dimming system



Apparecchio presente sia in versione indoor che in versione outdoor/ Device present in both indoor and outdoor version



Apparecchio a prova di dito articolato diametro 12mm/ Apparatus to test of articulate finger diameter 12mm.



Apparecchio a prova di protezione di sonda diametro 2,5mm/ Apparatus to test of probe penetration diameter 2,5mm



Apparecchio a prova di protezione di sonda diametro 1mm/ Apparatus to test of probe penetration diameter 1mm



Protezione contro la polvere/ Protected against dust





Protezione contro getti d'acqua/ Protected against jets of water



Protezione contro immersione temporanea/ Protected against temporary immersion

#### ECO-CONTRIBUTO / Normative RAEE D.L. 151/2015 H

Vi informiamo che la nostra società ha assolto l'obbligo dello smantellamento delle apparecchiature elettriche ed elettroniche associandosi al consorzio ECOLIGHT/ We inform you that our society has acquitted to the duty of the dismantling of electrical and electronic equipment by joining the consortium ECOLIGHT

Il simbolo  apposto su ogni prodotto ANTONANGELI indica che, per un suo migliore recupero, non deve essere smaltito insieme ad altri rifiuti domestici, ma conferito in idonei centri di smaltimento/ The symbol  on each ANTONANGELI product indicates that, for a better recovery, should not be disposed with other household waste, but given in suitable disposal sites

Antonangeli si riserva la facoltà di modificare, anche senza preavviso, i prodotti o parte degli stessi presenti in questo catalogo. / Antonangeli reserves the right to change the thecnical specifications of any product illustrated in this catalogue.

Antonangeli produce in Italia nella propria struttura e con il contributo di imprese che nel rispetto dell'ambiente non si avvalgono di manodopera minorile/ Antonangeli produces in Italy by its own structure and with the contribution of enterprises that taking care of environment do not use child labour.

## 100% MADE IN ITALY

Tutti i prodotti Antonangeli sono realizzati interamente in Italia  
All Antonangeli's products are made in Italy

Questo catalogo è stampato su carta "Magno natural" ottenuto da legni provenienti da risorse controllate nel rispetto dell'ambiente / This catalogue is printed on "Magno natural" paper obtained using wood from controlled resources respecting the environmentally.

ISO  
9001

ISO  
14001

ISO  
50001

ECF

## GARANZIA

i nostri prodotti, realizzati con materiali di alta qualità, vengono garantiti cinque anni da Antonangeli, per le parti strutturali e due anni per le fonti luminose e componenti elettronici, a partire dalla data di acquisto. La garanzia dà diritto alla riparazione o sostituzione gratuita di quelle parti di prodotto sulle quali si riscontrano difetti di fabbricazione, rilevati entro il periodo coperto dalla stessa. Esulano dalla garanzia danni causati da trasporto, derivanti da manomissioni o da manutenzioni improprie. In caso di difetto, il prodotto va riconsegnato, se possibile con imballo originale al rivenditore presso cui è stato acquistato, insieme al certificato di garanzia.

Ogni prodotto Antonangeli è coperto da polizza assicurativa per la responsabilità civile prodotti.

Per qualsiasi controversia sarà competente, in via esclusiva, il foro di Milano, Italia.

## WARRANTY

our products, made from high quality materials, are guaranteed by Antonangeli for five years for structural parts and two years for light sources and electronic components, from the date of purchase. The certificate warrants that those part of the product defective by improper workman ship will be replaced or repaired free of charge during all the period of guarantee's validity. This guarantee does not apply to shipping damage, misuse or improper maintenance. In case of defective parts the product must be handed, along with the guarantee certificate and if possibile in its original package to the dealer who sold it. All Antonangeli products are covered by an insurance policy.

Court of law competent to consider claims concerning this product is that of Milan, Italy.

Copyright Antonangeli October, 2024

E' vietata la riproduzione e l'utilizzo delle immagini di questo catalogo senza autorizzazione da parte di CHORE S.R.L. It is forbidden the use and the reproduction of the pictures present in this catalogue without the permission of CHORE S.R.L. Photo: F2 fotografia/Lorenzo Ceretta/Forte Studio/Andrea Pitari Project by Antonangeli/Graphic Design, Nicola Ravasio





Chore s.r.l. Via Como 74 20030 Paderno Dugnano (MI) Italy  
antonangeli.it info@antonangeli.it Phone: +39 02 91082795